

PACKAGING

INDUSTRY
BROCHURE

EN



PACKAGING INDUSTRY

Due to the years of expertise, we provide innovative solutions to specific packaging industry needs, offering a wide selection of belts for various manufacturing processes. You may find our products in the packaging equipment involved in the initial and final stages of production. Major applications of our standard and customised belts include: converting and die cutting equipment, form fill and seal, filling and capping machines, case erecting, case and tray packing, box filling and closing lines, palletizing and warehousing.

Megadyne has been catering to your needs since 1957, designing and manufacturing power transmission belts, matched components, and complete belt systems for all types of equipment. We are a reliable partner for original equipment manufacturers and aftermarket distributors, with:

9 manufacturing plants in Europe, North America, and Asia, more than 170 Customer Solution Centres and 3 main distribution hubs around the world, able to deliver products efficiently, from large industrial sites to remote locations.

BELT PROPERTIES



MEGADYNE MEGASYNC™ RUBBER ENDLESS TIMING BELTS

SUPPLIED AS	Endless
LENGTH	248 - 4 956 mm
WIDTH	12 - 170 mm*
PITCH	L, H, RPP8, RPP14, SLV3 8M, SLV3 14M
TENSION MEMBER	Fiberglass
FEATURES	High-stability and power transmission

*Standard Width Range - Megadyne will cut to desired width upon request.

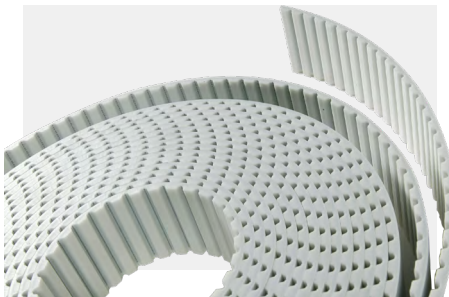

MEGADYNE POLYURETHANE TIMING BELTS

SUPPLIED AS	Open-ended roll - Endless - Joined - PPJ
LENGTH	MEGALINEAR 0.5 - 100 m MEGAFLEX 1.5 - 22.60 m
WIDTH	6 - 150 mm
PITCH	T5, T10, T20, AT5, AT10, AT20, RPP8, RPP14, MTD8, MTD14, TG10, ATG10, TG20, ATG20
TENSION MEMBER	Steel - HP - HF - HPF - Stainless Steel - Kevlar®
FEATURES	High-resistance belts available in different lengths

METAL DRIVE COMPONENTS

Use an extensive range of pulleys and accessories like timing bars, flanges, clamping plates, couplings to design a complete drive transmission system.

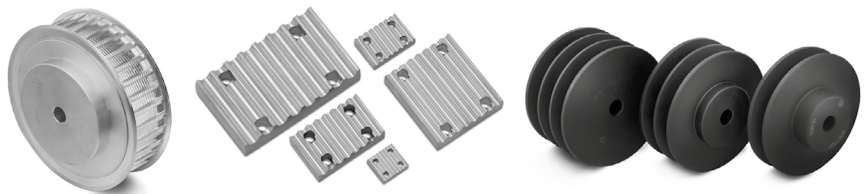

SPECIAL COVERS

AVAFC 60/70/85

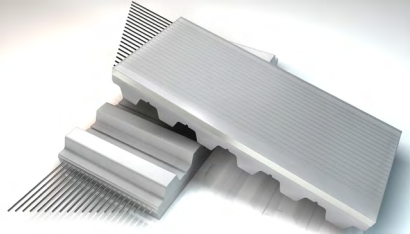

MATERIAL Polyurethane

COLOUR Transparent

Excellent cut and wear-resistance and good oil-resistance.

LINATEX™ RED

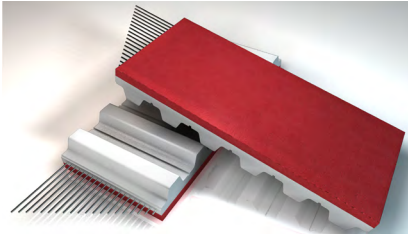

MATERIAL Natural Rubber

COLOUR Red

Cover offers high CoF, good wear resistance, good wet conditions.

DURATAQ™

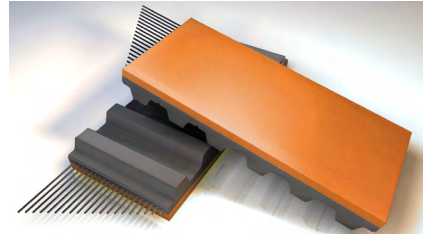

MATERIAL Natural Rubber

COLOUR Orange/Red

Cover offers a proprietary custom blended rubber which has a good CoF and very good abrasion-resistance.

NFB/NFT

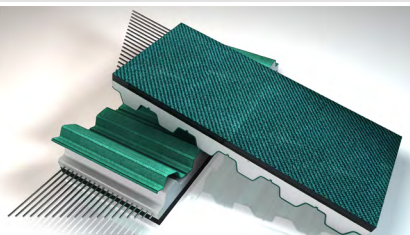

MATERIAL Nylon Fabric

COLOUR Green

NFT/NFB offers low friction for accumulation as well as low noise benefits and is usually applied coextrusion on base belts.

SUPERGRIP PETROL

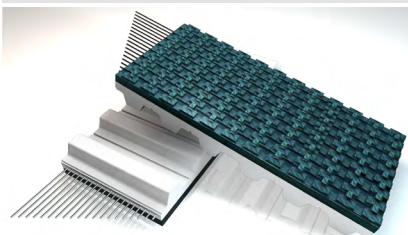

MATERIAL PVC

COLOUR Petrol Green

High CoF, applicable for slight height compensation, low shock-absorption capabilities. Improved adhesion even in case of moisture and dirt.

RED GRIP



MATERIAL PU/Synthetic Rubber

COLOUR Red

A seamless alternative to LINATEX™. Only available on MEGAFLEX.

SILICONE

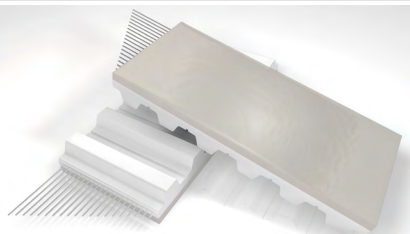

MATERIAL Silicone

COLOUR White/Beige/Black/
Transparent/Blue/Red

Cover offers a good CoF and very good abrasion-resistance.

NBR

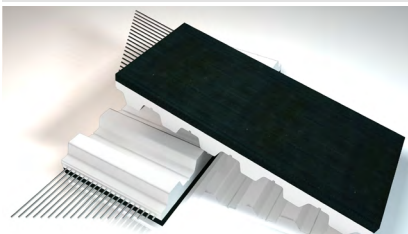

MATERIAL Nitrile Caoutchouc

COLOUR Black

Cover offers improved oil and grease resistance compared to natural rubber.

RP 400 YELLOW

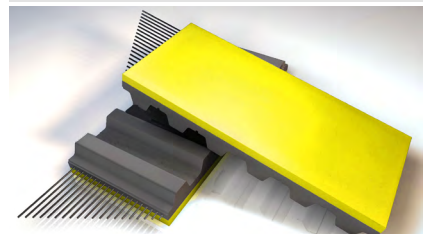

MATERIAL Caoutchouc

COLOUR Yellow

Cover has fine fabric texture, characteristics similar to LINATEX™ but higher abrasion resistance.

SLOTS WITH HOLES



PROFILES GROUND IN COVER

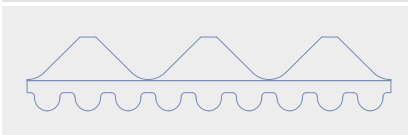

DIAGONAL GROOVES

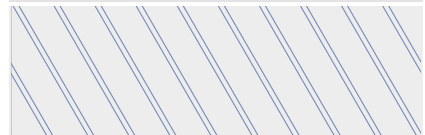

LUG GRIND

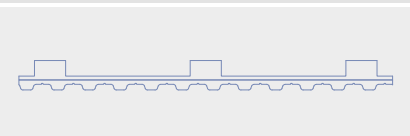

CONVEX GRIND

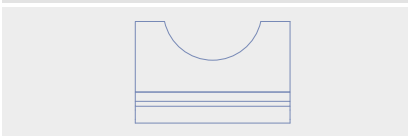

COUNTERSINKS WITH HOLES



INSPECTION MACHINE

The foam coated belts allow to accommodate different bottle shapes and dimensions, leading to a faster, more flexible and functional production. Moreover, the friction of the rubber foam ensures a perfect grip to hold bottle in position, for a perfect and precise scan by the vision system.



FOAM COVERED RUBBER TIMING BELT

Equipped with foam coating.

- High-friction coefficient and high compression set to accommodate different product shapes
- Suitable for handling fragile products

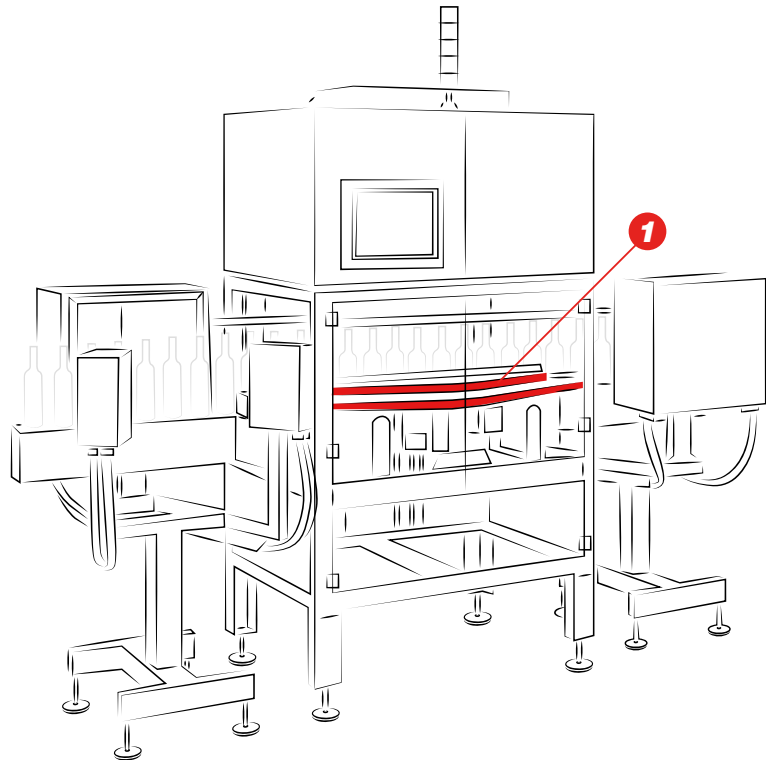

FILLING LINES

MEGALINEAR and MEGAFLEX belts used for bi-directional dispensing head-positioning ensure precise and smooth movement at high-speeds.

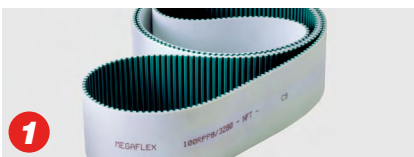

POLYURETHANE TIMING BELTS

Thermoplastic PU belts, supplied as open-length rolls or as endless joined belts; available in various tooth designs and grades of steel cord.

- High-positioning precision suitable for linear movement and lifting systems

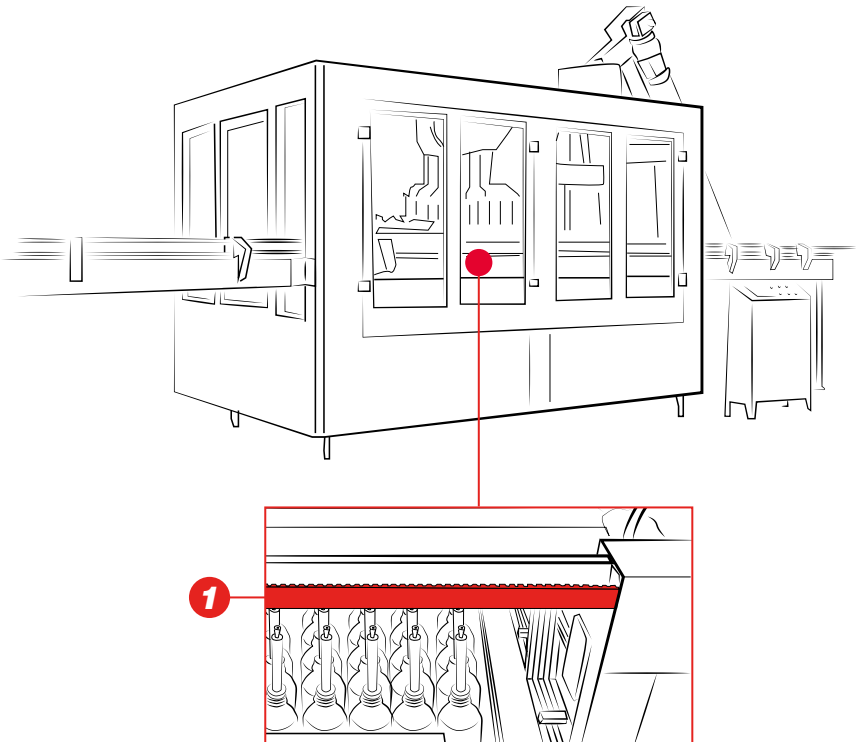

CAPPING

Feed belts with the right amount of friction and cushioning to move, hold and cap bottles.



SPECIAL POLYURETHANE TIMING BELTS

- Equipped with Silicone coated foam
- High-friction
- Non-marking



DRY BACK V-BELT

Wrapped V-belt with non-marking wrapped fabric

- High-resistance to oil and steam
- Non-marking

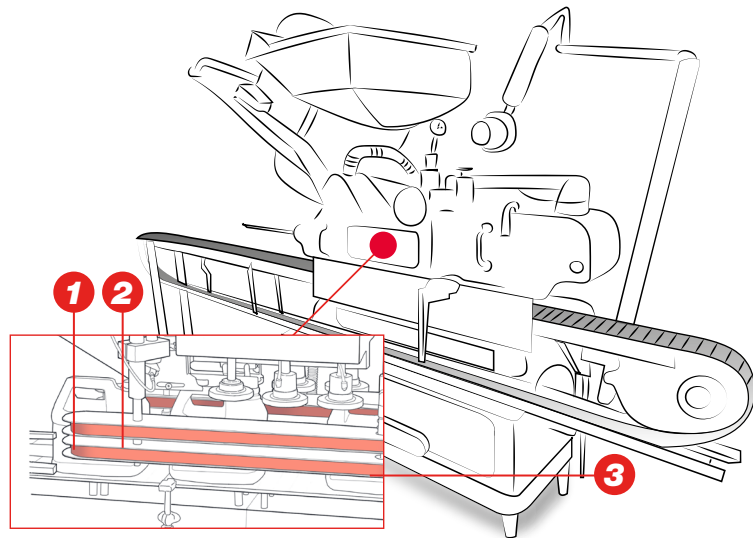

SPECIAL RUBBER FLAT BELTS

Truly endless flat rubber moulded belts equipped by special covers

- Non-marking with high friction cover
- Smooth-running and length stability

VERTICAL FORM FILL & SEAL

Synchronous belts with moulded covers provide the right friction and wear-resistance to get the job done. With the vast number of film and media types used today to create bags, the right choice of non-glazing cover can make the difference between efficient and non-efficient bag handling and filling. Modifications such as holes, slots and grooves for vacuum can be added to meet your specific application requirements.

SPECIAL REWORKED BELTS

Truly endless moulded belts polyurethane or rubber based. Wide range of different materials, to ensure the best performances and the best match to the varied grades of film used. Grinded tooth and holes to ensure the best vacuum and grip performances.



VFFS belts with sprayed PU foam cover



VFFS belts with Silicone



VFFS belts with anti-glaze cover



VFFS belts with rubber coating and vacuum holes and slots



VFFS belts with dual durometer polyurethane

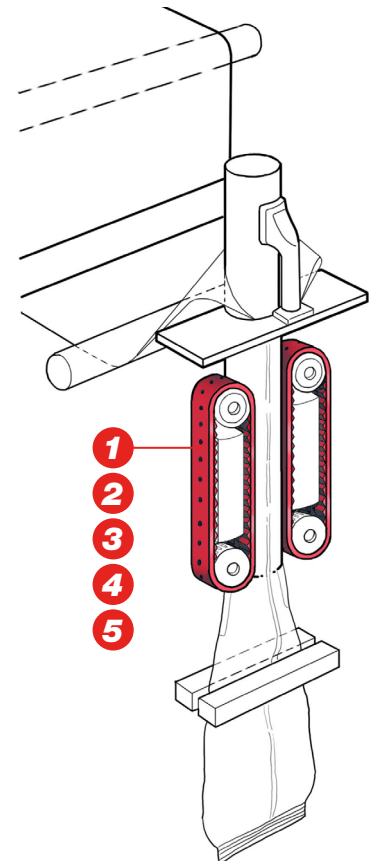

CASE ERECTING AND CASE & TRAY PACKAGING

After boxes are formed, the product is inserted into cases or trays. To get a precise and optimal box filling are needed belts that offer features like high-friction, non-slip covers and cleats for sortation and accurate product placement.

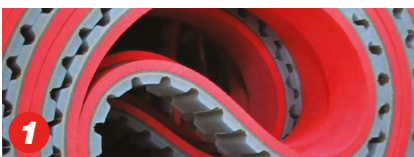
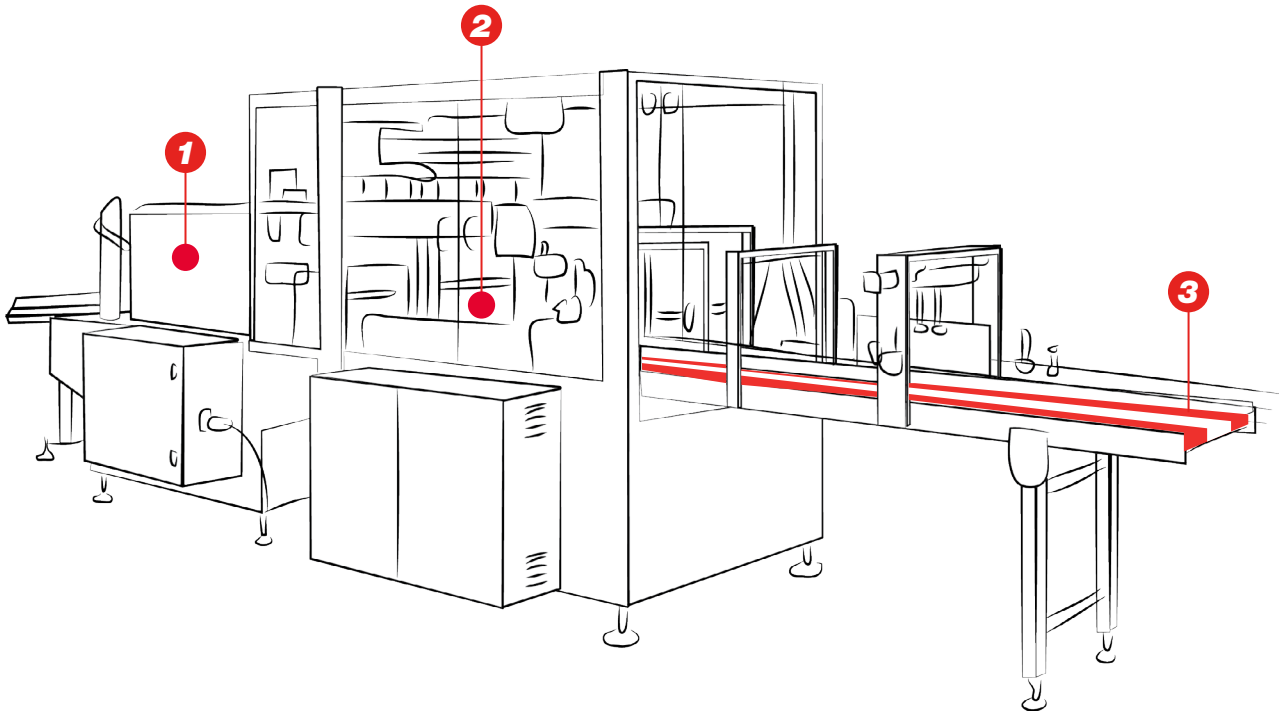

SPECIAL POLYURETHANE BELTS

Polyurethane moulded/laminated or joined belts with backing materials according to application demands.

- Non-marking
- High-friction even in high-speed conveying



SPECIAL POLYURETHANE BELTS

Polyurethane timing belt with welded cleats.

- High-frequency welding for maximum precision and adhesion
- Possibility to have cleat profile according to customer's drawing to match the package shape



SPECIAL RUBBER BELTS

Rubber timing belts made of high-quality rubber compounds, and high performance tension members.

- Supplied with high-friction non-marking homogenous cover

BOXING AND WRAPPING EQUIPMENT

After products are packed in cartons or trays, they are then inserted into boxes. During this process, belts are used to guide and support the box through sealing, labelling and weighing processes.

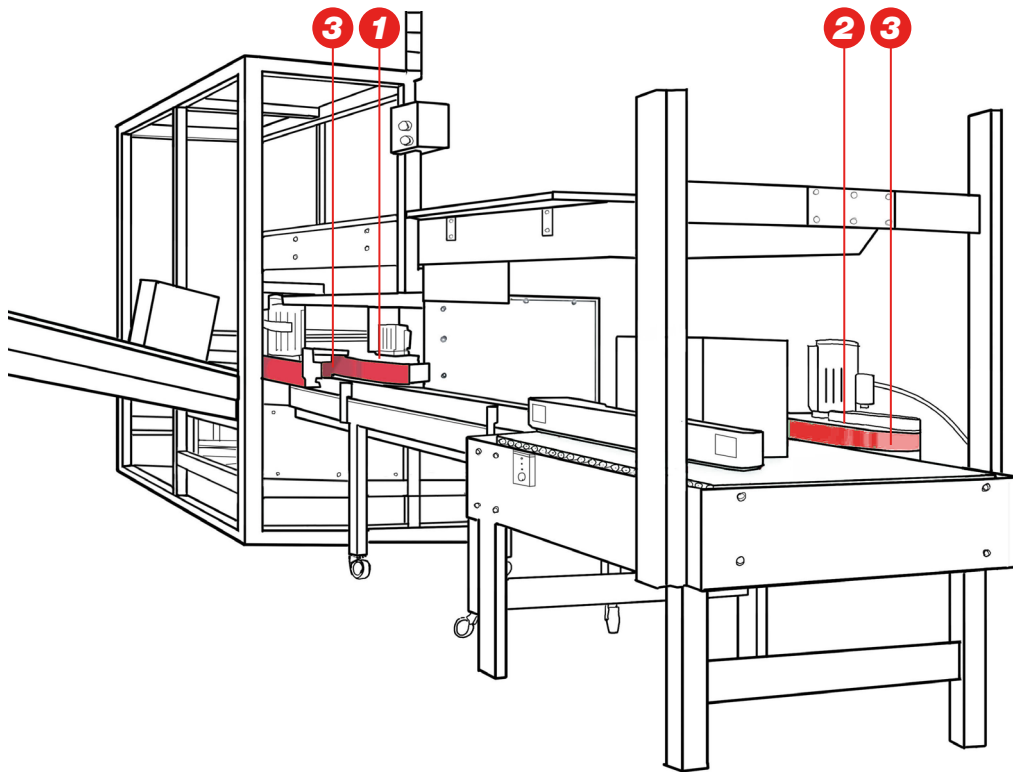

SPECIAL POLYURETHANE BELT

Supplied with DuraTaq™ cover.

- High-friction
- Low-wear



SPECIAL ENDLESS POLYURETHANE BELTS

Special belts with rubber coating.

- Supplied with high-friction non-marking homogenous cover

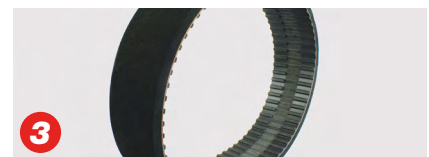

FOAM COVERED TIMING BELT

Equipped with foam coating.

- Suitable for handling fragile products

LABELING MACHINE

The variety of coatings we offer ensures the perfect label application. Label will be applied on package in the perfect spot with high and precise repeatability, avoiding marks, bubbles or creases.

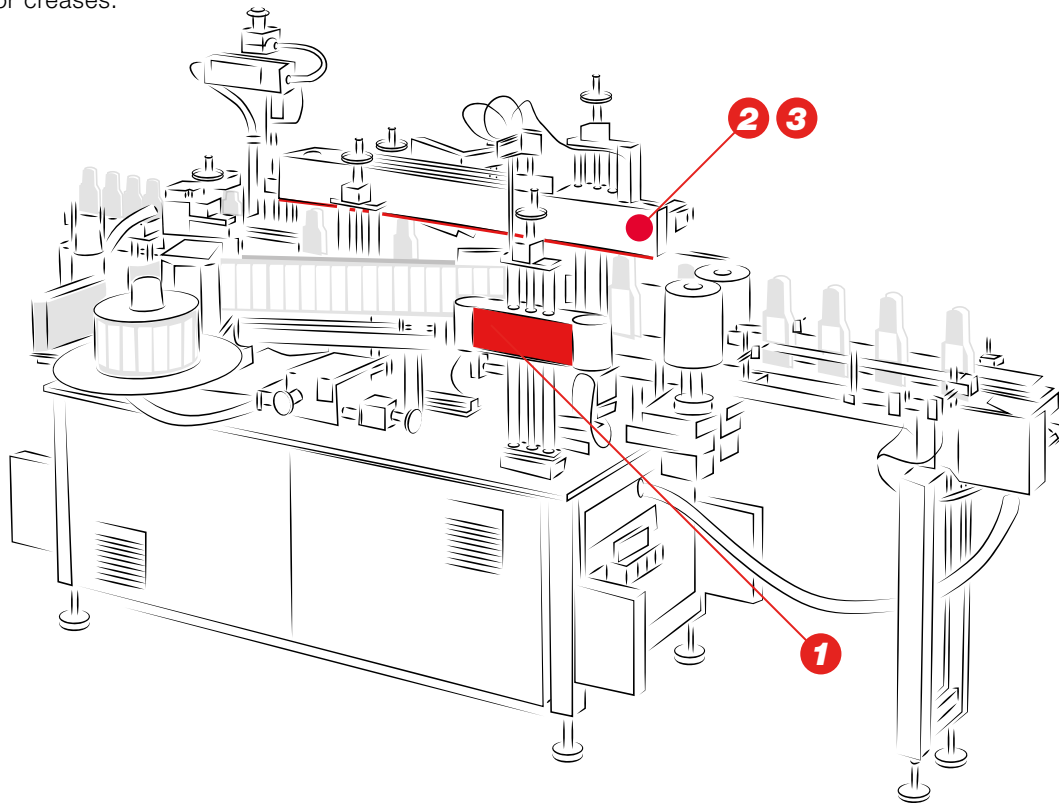

SPECIAL RUBBER BELTS

Rubber timing belts made of high-quality rubber compounds, and high performance tension members.

- Supplied with high-friction non-marking homogenous cover



FOAM COVERED TIMING BELT

Equipped with with foam coating.

- High-friction coefficient and high compression set to accommodate different product shape
- Suitable for handling fragile products



SPECIAL POLYURETHANE BELTS

Polyurethane moulded/laminated or joined belts with backing materials according to application demands.

- Non-marking
- High-friction even in high-speed conveying

ROTARY FILLING MACHINES

Rotary filling machines are the best in class in terms of volume of bottle per minute. Construction is more complex and different concept can be used by the manufacturer. Power transmission truly endless polyurethane belts provide the synchronism of each rotary wheel in the machine: precise and accurate positioning is mandatory.

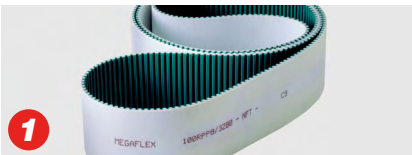
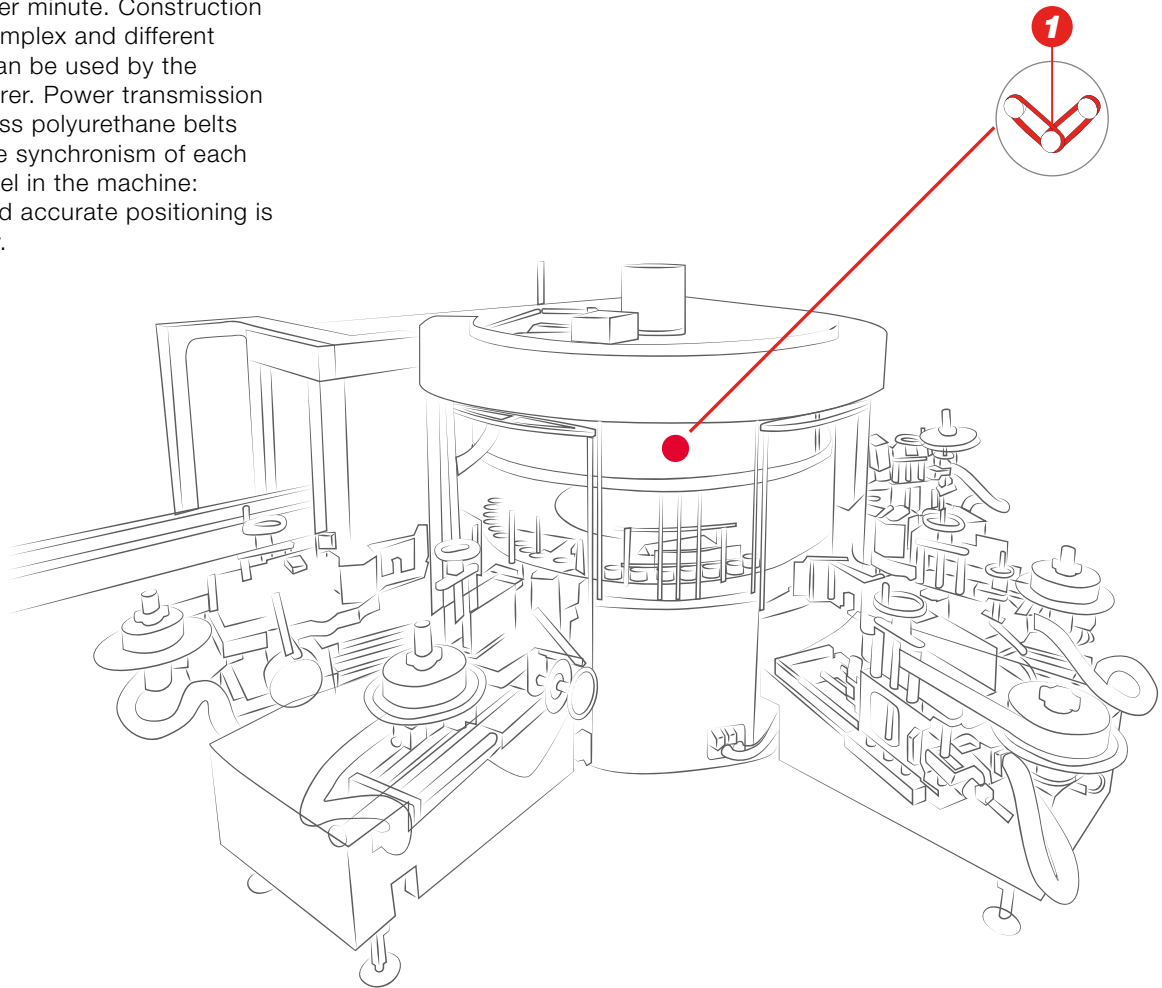

MEGAFLEX

Truly endless timing belts with thermoplastic polyurethane and high strength helically wound zinc coated steel tension members.

- Customized with special covers
- High-friction
- Wear-resistance
- Low-elongation and high-stability

LINEAR FILLING MACHINES

Linear filling machines are widely used in the market because they are compact and easy to change format or size of the product to process. Timing belts are widely used to either convey the product or to move the filling heads.

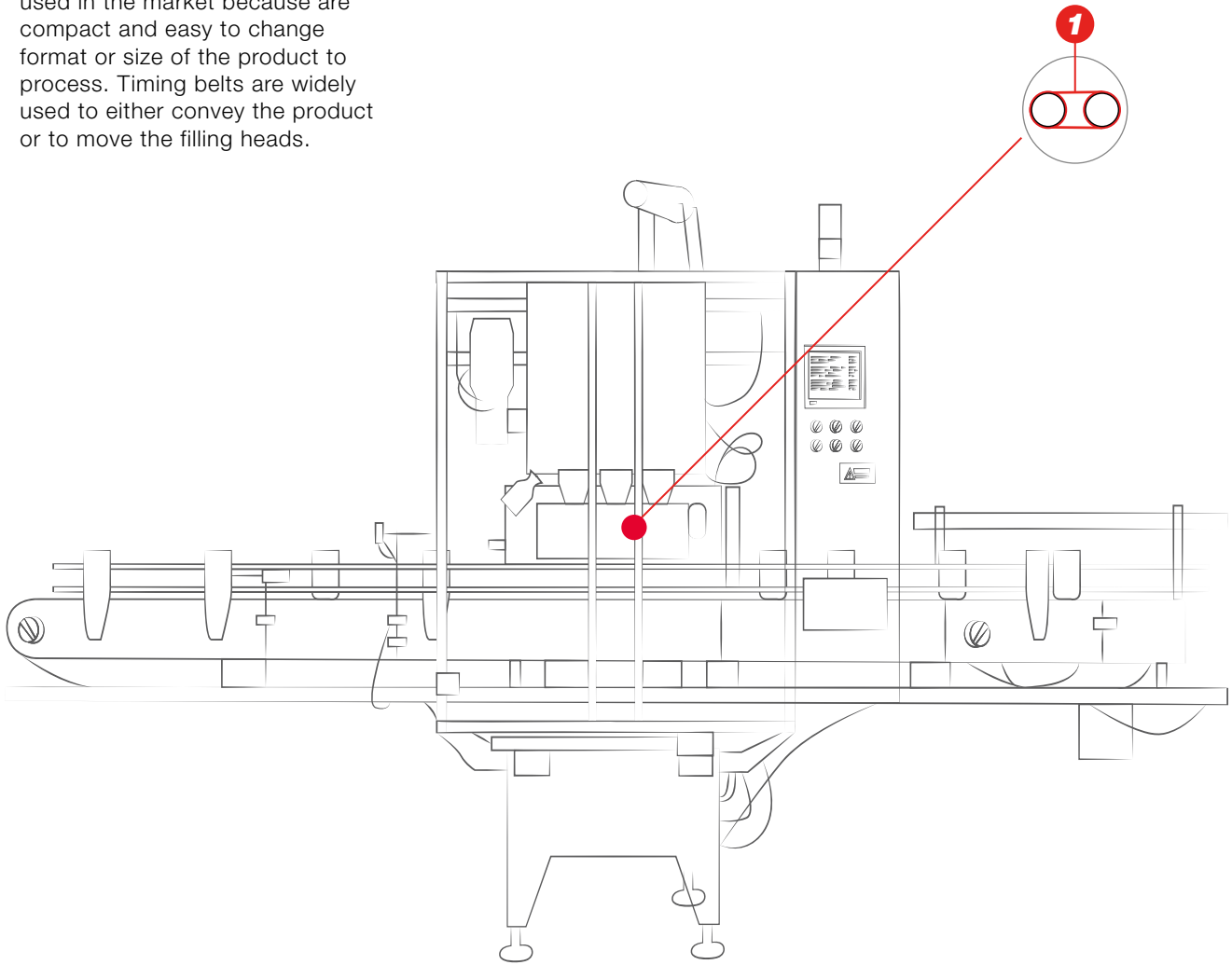

MEGALINEAR

Thermoplastic PU 92 ShA belts, supplied as open-length rolls or as endless joined belts; available in various tooth designs and cords. Recommended belts: joined endless with special covers.

- Low-elongation and high-stability
- High-friction and wear-resistance



MEGASYNC™

MEGASYNC™ made of high-quality rubber compounds, and high-performance tension members.

- Moulded to length and pitch designation
- High-performance
- Low-noise



CASE STUDY

APPLICATION: Food packaging
 PREVIOUS SOLUTION: Non-synchronous flat conveyor belt
 PREVIOUS BELT PROBLEM: Belt slippage, lack of synchronization,
 expensive downtime and high-cost of spare parts.

MEGALINEAR TIMING BELT WITH FDA CLEATS

MEGALINEAR timing belt for synchronization joined with PPJ joint system for fast and easy belt replacement and weld on cleats for product separation.

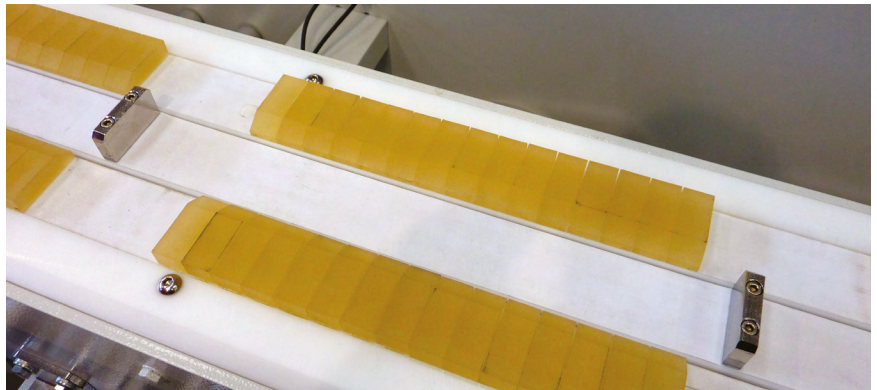

CERTIFICATIONS



All Megadyne polyurethane power transmission belts comply with ISO 14001, ISO 9001 and European RoHS Directive. The belts are made with raw materials in compliance with REACH standards, meaning that all belts, pulleys, toothed bars, couplings blocking units and other items supplied by Megadyne do not contain one (or several) of the SVHC in Candidate List above a concentration of 0.1% w/w.

All Megadyne rubber power transmission belts are made in accordance with the Quality Management System Standard: ISO 9001 and ISO 14001. These certificates are valid for the following field of application: design, manufacture and sale of power transmission belts. Marketing of transmission and transport elements (pulleys, tensiometers).

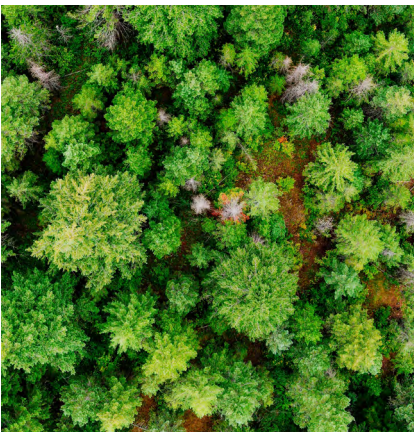

ABOUT SUSTAINABILITY

Sustainability has always been a guiding principle for Ammega and all members of Ammega Group. We are proud to work with **EcoVadis** to monitor and evaluate our environmental, social, and ethical performance.

At Megadyne, we are committed to becoming more and more responsible towards the world by reducing our impact on the planet. We work on new technological raw materials made by partners using the most ecological sustainable technologies. Our team has been working on the continuous improvement of products, services, and solutions for the benefit of society and the environment. Our vision is to be the local partner of choice for sustainable belting solutions around the globe.

Discover Your Local Contacts

The local partner of choice
for sustainable power transmission belting solutions
around the globe.



General contact information:

Megadyne

Via Trieste, 16
Via S. Lucia 114 - 10075 Mathi (Torino)
Italy



Scan the QR code
and find your local
contact

