



MEGADYNE



**MARBLE
& CERAMIC**

INDUSTRY
BROCHURE

EN



MARBLE & CERAMIC

Years of expertise and close cooperation with major manufacturers in marble and ceramic industry have allowed us to develop a range of solutions fitting their specific requirements. We are convinced that the quality and suitability of a belt is a crucial factor, which translates into the operability and efficiency of your business.

Megadyne has been catering to your needs since 1957, designing and manufacturing power transmission belts, matched components, and complete belt systems for all types of equipment. We are a reliable partner for original equipment manufacturers and aftermarket distributors, with:

9 manufacturing plants in Europe, North America, and Asia, more than 170 Customer Solution Centres and 3 main distribution hubs around the world, able to deliver products efficiently, from large industrial sites to remote locations.

BELT PROPERTIES



MEGADYNE MEGASYNC™ (TITANIUM, GOLD2, SILVER3)	
SUPPLIED AS	Endless
LENGTH	248 - 4 956 mm
WIDTH	12 - 170 mm*
PITCH	TTM8, TTM14, GLD2 8M, GLD2 14M, SLV3 8M, SLV3 14M
TENSION MEMBER	Special Carbon Cord; Fiberglass
FEATURES	High-stability and resistance

**Standard Width Range - Megadyne will cut to desired width upon request.*



MEGADYNE POLYURETHANE TIMING BELTS	
SUPPLIED AS	Open-ended, endless, joined, PPJ
LENGTH	MEGALINEAR 0.5-100 m; MEGAFLEX 1,5 - 22,60 m
WIDTH	12 - 150 mm
PITCH	AT10, AT20
TENSION MEMBER	Steel - HP - HF - HPF - Stainless Steel - Kevlar®
FEATURES	High-resistance belts available in different lengths



MEGADYNE V-BELTS	
SUPPLIED AS	Endless - Wrapped - Raw edge
LENGTH	Consult Megadyne
WIDTH	According to section
PITCH	Wrapped A, B; Narrow SPA, SPB
TENSION MEMBER	Polyester
FEATURES	Long life and good performance



MEGADYNE MEGAWELD	
SUPPLIED AS	Joined, open-ended
LENGTH	Consult Megadyne
WIDTH	According to section
PITCH	PT85, PT85RK, PT90, PT90RK
TENSION MEMBER	Polyester, Aramide
FEATURES	Long life and good performance

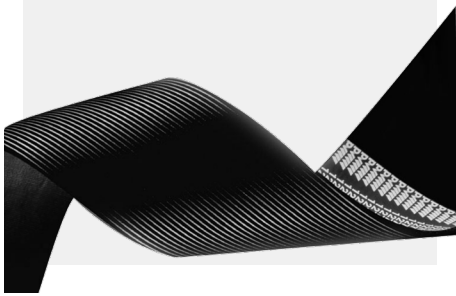

MEGADYNE PV RIBBED BELTS	
SUPPLIED AS	Endless
LENGTH	PK 588 - 2555 mm; L 953 - 5029 mm
WIDTH	Consult Megadyne
PITCH	PK, PL
TENSION MEMBER	Polyester
FEATURES	Long life and good performance

METAL DRIVE COMPONENTS

Use an extensive range of pulleys and accessories like timing bars, flanges, clamping plates, couplings to design a complete drive transmission system.

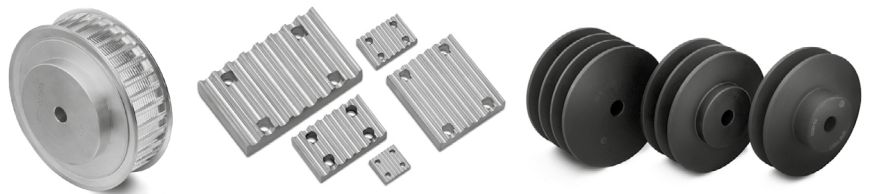

SPECIAL COVERS

AVAFC 60/70/85

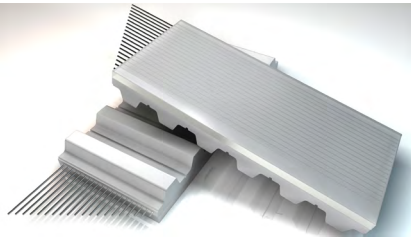

MATERIAL Polyurethane
COLOUR Transparent

Excellent cut and wear-resistance and good oil-resistance.

PU FISHBONE

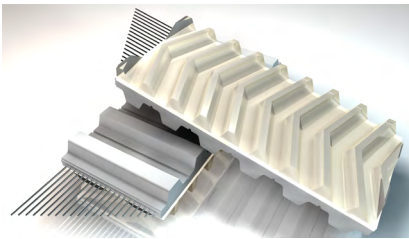

MATERIAL Polyurethane
COLOUR Transparent

Suitable for wet environments where friction and drainage are necessary.

PU RIBBED

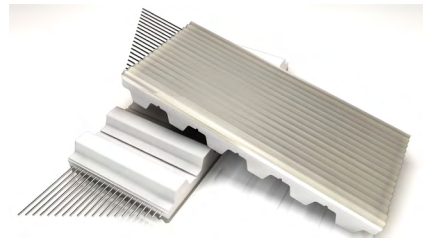

MATERIAL Polyurethane
COLOUR Transparent

Reduced contact points for conveying smooth products. Allows drainage of liquids.

NP 385

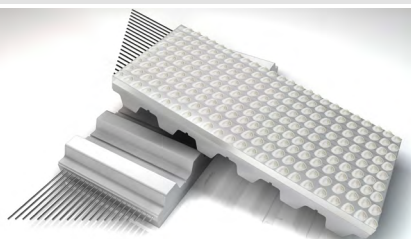

MATERIAL Polyurethane
COLOUR Transparent

For oily conveyor conditions (contact only on top of the Noppen).

APL RED

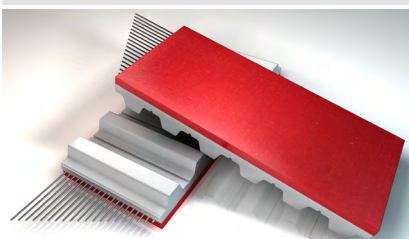

MATERIAL Polyurethane/PVC
COLOUR Red

Seamless alternative to LINATEX™. Blended elastomer offering high CoF, good oil resistance.

SUPERGRIP PETROL

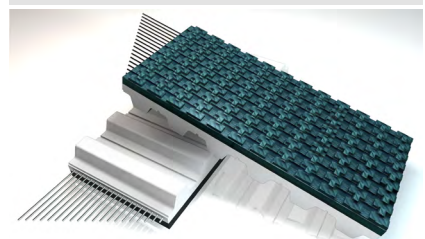

MATERIAL PU/Synthetic Rubber
COLOUR Petrol Green

High CoF, applicable for slight height compensation, low shock-absorption capabilities. Improved adhesion even in case of moisture and dirt.

LINATEX™ RED

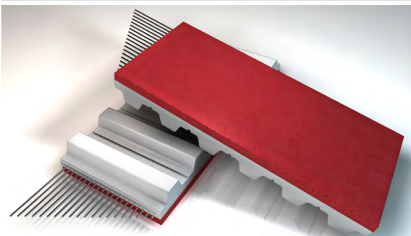

MATERIAL Natural Rubber
COLOUR Red

Cover offers high CoF, good wear-resistance, also in wet conditions.

RED GRIP

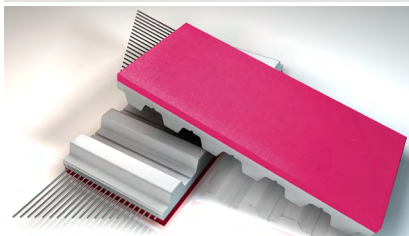

MATERIAL PU/Synthetic Rubber
COLOUR Red

A seamless alternative to LINATEX™. Only available on MEGAFLEX.

NFB/NFT

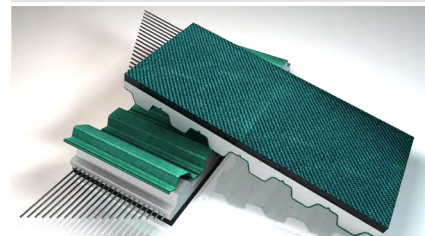

MATERIAL Nylon Fabric
COLOUR Green

NFT/NFB offers low friction for accumulation as well as low noise benefits and is usually applied coextrusion on base belts.

TENAX STANDARD / 40

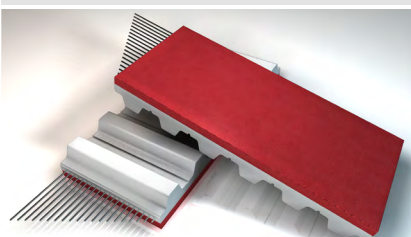

MATERIAL Natural Rubber
COLOUR Red

TENAX STANDARD - TENAX 40
High-grip with good wear-resistance.

BLOCK CUTTERS

Open frame multiwire machines are the most popular choice when cutting marble and granite slabs: the blocks are sliced quickly by means of a set of diamond wires. The number of diamond wires can vary, but power and reliability are a “must”. OEM leaders in this sector choose Megadyne to supply complete power transmission systems.

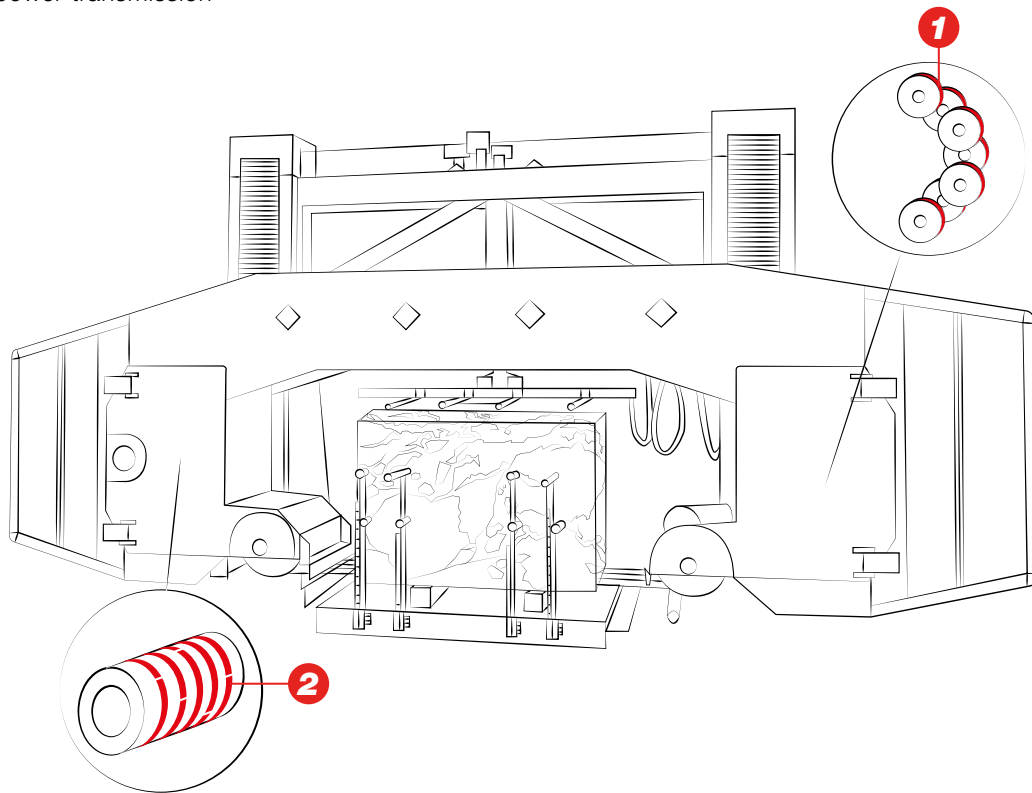

MEGAWELD

Thermoplastic PU belts with different hardnesses and custom cross sections.

- High-flexibility and grip
- Excellent resistance to ageing and abrasion



MEGALINEAR

Thermoplastic PU 92 ShA belts and S & Z parallel cord. Supplied as open-length rolls or as endless joined belts; available in various tooth profiles and cords.

- Customized solution
- High wear-resistance
- High-flexibility
- Maintenance-free

DRUM MILLS

When turning the heavy drums, a powerful belt is necessary, also to ensure stability.

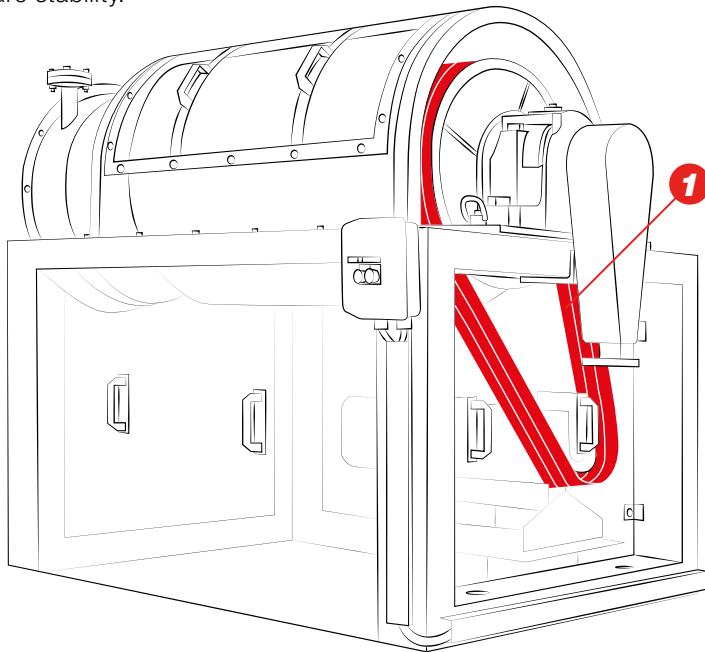

OLEOSTATIC GOLD

Top of the line in rubber wrapped V-belts; extremely wide horsepower ranges.

- Oil and heat-resistant
- Long service-life
- Lubrication-free
- Low maintenance costs

SQUARING MACHINES

The ultimate squaring machines double the speed of the production. The challenge has been to improve the performance of the belt and its wear-resistance, lowering the maintenance-time and reducing the production scraps.

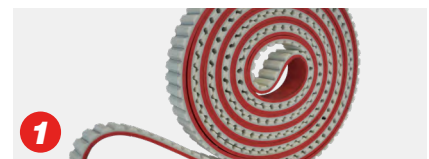
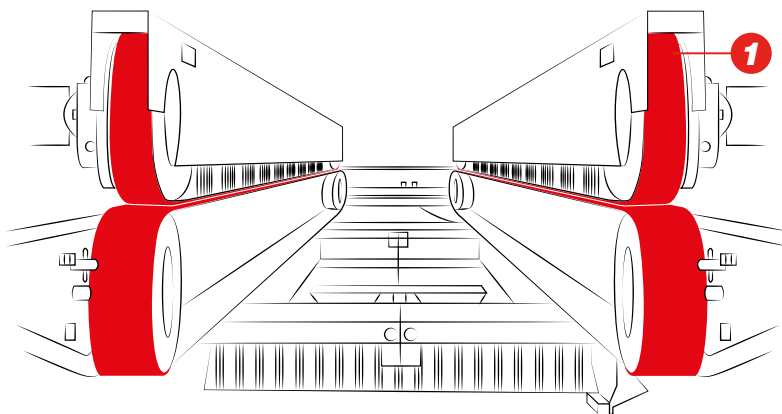

MEGAFLEX

Truly endless timing belts with thermoplastic polyurethane and high-strength helically wound zinc coated steel tension members.

- Customized with special covers (TENAX, AVAFC, LINATEX™, RED GRIP...)
- Low-elongation and high-stability
- Enhanced grip

CHAMFERING MACHINES

The Megadyne solution for chamfering machines allows an excellent quality/price ratio, and a smooth transport of the slabs during the finishing process.

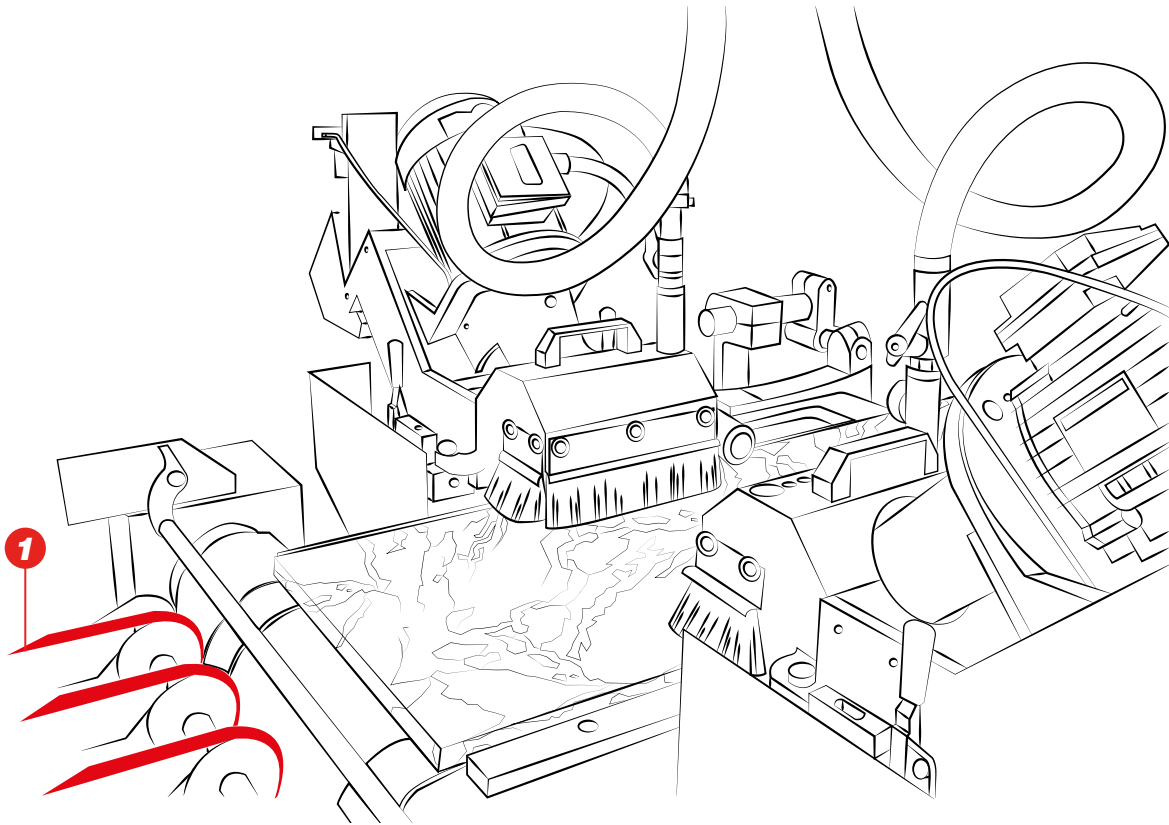

MEGAWELD

Thermoplastic PU belts with different hardnesses and custom cross sections.

- High-flexibility and grip
- Excellent resistance to ageing and abrasion



V-BELT

Wrapped V-belts, made of polybutadiene compound in a wide variety of sizes (Extra, Section C).

- Smooth-running operation
- High-transmission efficiency

SLAB & TILE POLISHING MACHINES

In these machines, belts are used in two different applications:
lateral movement of the trolley and
rotational movement of the brushes.

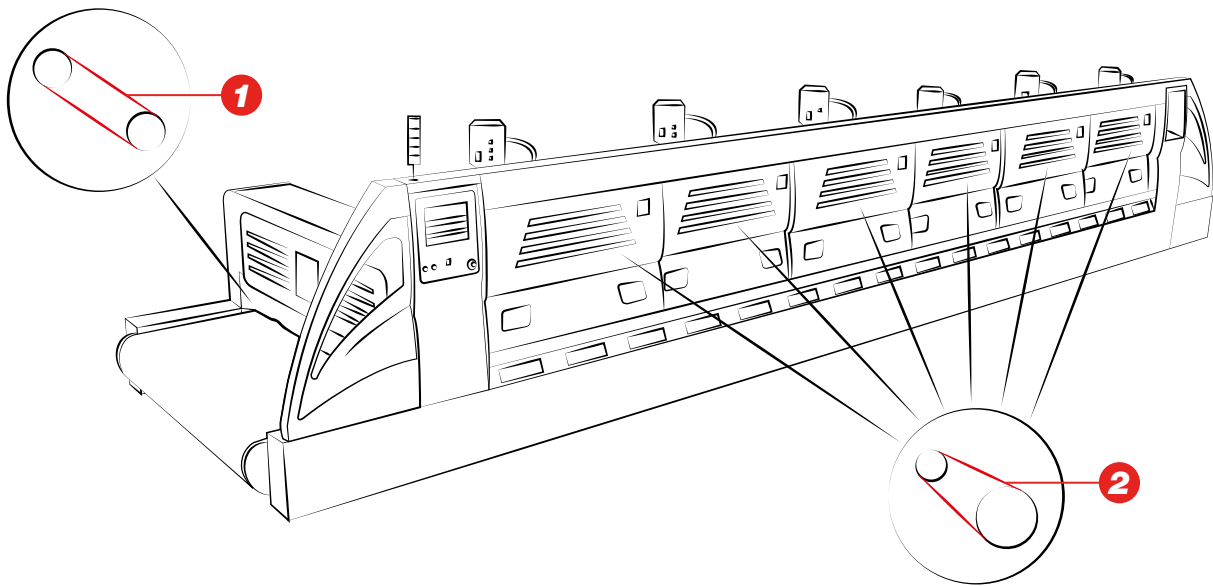

MEGALINEAR

Thermoplastic PU 92 ShA belts with S & Z parallel cords. Supplied as open-length rolls or as endless joined belts; available in various tooth profiles and cords.

- Used in linear motion drives (speed up to 20 m/s)
- Constant dimension and length
- High-resistance to oil, grease and ageing



MEGADYNE MEGASYNC™

Rubber endless timing belts made of high-quality rubber compounds and spiral fiberglass tension members (special carbon cord for Titanium).

- High-power rating
- Reduced width and compact pulleys

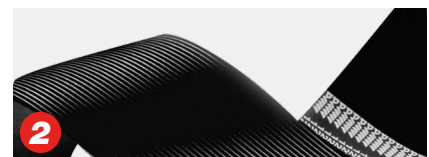

PV RUBBER RIBBED BELTS

Endless belts with longitudinal V-shaped grooves which combine the benefits of flat belts and V-belts.

- High-flexibility
- Improved power performance by increasing the number of ribs
- Compact smooth-running drive system with low vibration

ROLLER UNITS

Over the last few years, the request for larger tiles has increased, therefore the load on the roller conveyors are also increased. Accordingly, Megadyne now provides new and upgraded products to fulfill the higher performance requirement.

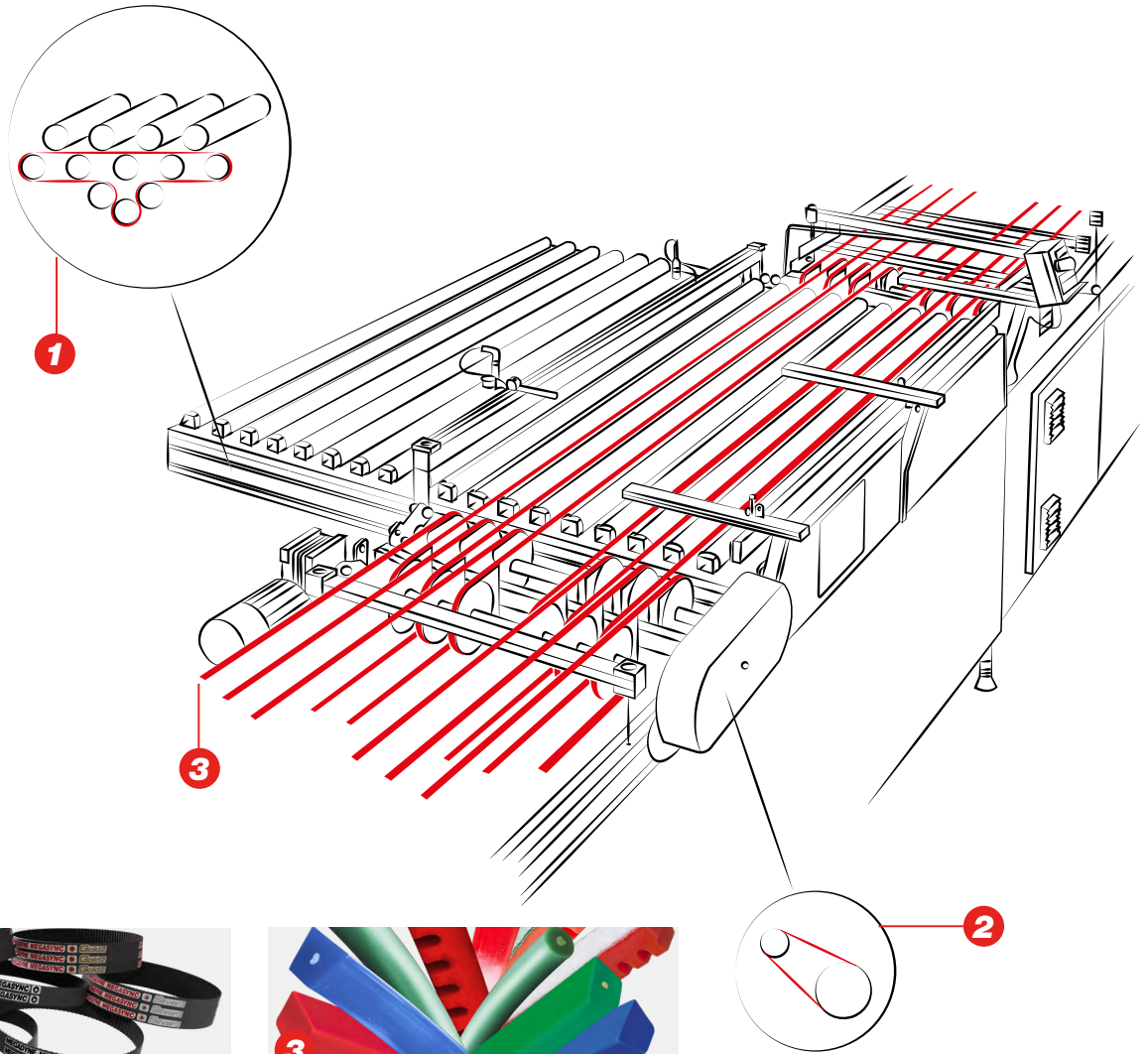

MEGADYNE MEGASYNC™

Rubber endless timing belts made of high-quality rubber compounds and spiral fiberglass tension members (special carbon cord for Titanium).

- High-power rating
- Reduced width and compact pulleys



MEGAWELD

Thermoplastic PU belts with different hardnesses and custom cross sections.

- High-flexibility and grip
- Excellent resistance to ageing and abrasion

CERAMIC CONVEY

More than one belt is used while transporting delicate goods towards packaging. These belts are designed to ensure a reduced contact area and guarantee adhesion to its special "soft" surface.

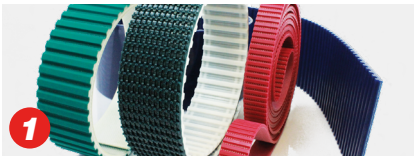
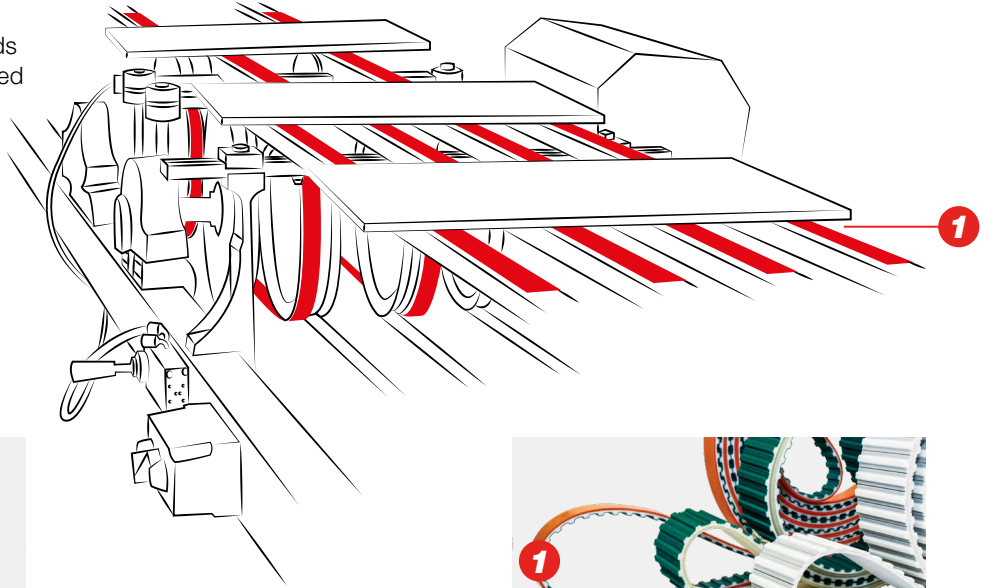

MEGALINEAR

Thermoplastic PU 92 ShA belts with S & Z parallel cords. Supplied as open-length rolls or as endless joined belts; available in various tooth profiles and cords.

- Customized with special covers (TENAX, AVAFC, LINATEX®, RED GRIP...)
- Low-elongation and high-stability
- High-friction and wear-resistance



MEGAFLEX

Truly endless timing belts with thermoplastic polyurethane and high-strength helically wound zinc coated steel tension members.

- Customized with special covers (TENAX, AVAFC, LINATEX®, RED GRIP...)
- Low-elongation and high-stability
- Enhanced grip

OPTICAL CONTROLLERS

This advanced automated machine is able to examine the surface texture and decoration of large-size tiles and slabs for accurate inspection of structural and decoration defects. The application requires micrometric positioning: precision, accuracy and smooth running are crucial features of the belts used.

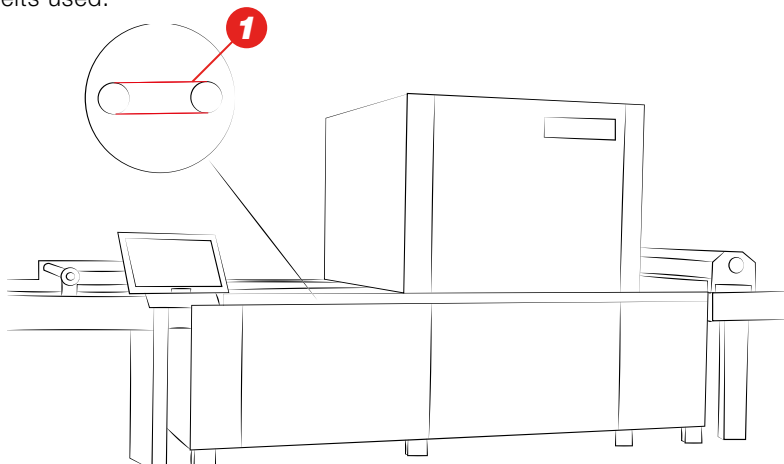

MEGALINEAR

Thermoplastic PU 92 ShA belts with S & Z parallel cords. Supplied as open length rolls or as endless joined belts; available in various tooth profiles and cords.

- Designed to ensure precise position, constant dimension and length
- Maintenance-free

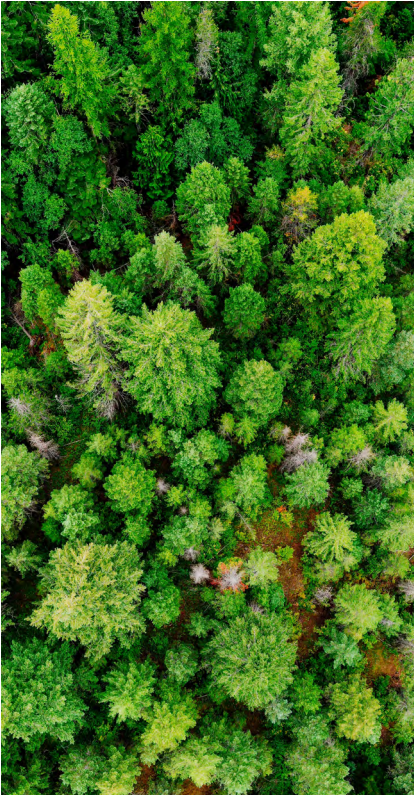

ABOUT SUSTAINABILITY

Sustainability has always been a guiding principle for Ammega and all members of Ammega Group. We are proud to work with **EcoVadis** to monitor and evaluate our environmental, social, and ethical performance.

At Megadyne, we are committed to becoming more and more responsible towards the world by reducing our impact on the planet. We work on new technological raw materials made by partners using the most ecological sustainable technologies. Our team has been working on the continuous improvement of products, services, and solutions for the benefit of society and the environment. Our vision is to be the local partner of choice for sustainable belting solutions around the globe.

Important sustainability achievements include improvements throughout the supply chain and in tracking our carbon footprint as well as the launch of new sustainable solutions for our clients. Major steps forward on sustainable investments are slowly bringing us closer to goals set in the Paris Agreement. We are on a journey towards a sustainable future, continually revising our plans and raising the level of our ambitions wherever possible. Our business performance and successes are key factors in defining our impact on the economic, social, and natural environment. We take the responsibility for this impact for all stakeholders and make every endeavour strengthen our roles as conscientious corporate citizens.

CERTIFICATIONS



All Megadyne polyurethane power transmission belts comply with ISO 14001, ISO 9001 and European RoHS Directive. The belts are made with raw materials in compliance with REACH standards, meaning that all belts, pulleys, toothed bars, couplings blocking units and other items supplied by Megadyne do not contain one (or several) of the SVHC in Candidate List above a concentration of 0.1% w/w.

All Megadyne rubber power transmission belts are made in accordance with the Quality Management System Standard: ISO 9001 and ISO 14001. These certificates are valid for the following field of application: design, manufacture and sale of power transmission belts. Marketing of transmission and transport elements (pulleys, tensiometers).

Discover Your Local Contacts

The local partner of choice
for sustainable power transmission belting solutions
around the globe.



General contact information:

Megadyne

Via Trieste, 16
Via S. Lucia 114 - 10075 Mathi (Torino)
Italy



Scan the QR code
and find your local
contact

