



MEGADYNE



***ELEVATORS,
ESCALATORS
& DOORS***

INDUSTRY
BROCHURE

EN



ELEVATORS, ESCALATORS & DOORS

Low noise, reliability, security, and long service life – these are must-have features. Our solutions support the vertical movement systems, offering the highest level of operational safety and maximum efficiency along with high-load torque and silent drive standards. Find our products in such sectors as: elevators, escalators, automatic doors, sliding doors, garage doors, roll-up doors, and turnstiles.

Megadyne has been catering to your needs since 1957, designing and manufacturing power transmission belts, matched components, and complete belt systems for all types of equipment. We are a reliable partner for original equipment manufacturers and aftermarket distributors, with 9 manufacturing plants in Europe, North America, and Asia, more than 170 Customer Solution Centres and 3 main distribution hubs around the world, able to deliver products efficiently.

BELT PROPERTIES



TRACTION BELTS MEGALINEAR P3.3	
SUPPLIED AS	Open-ended
LENGTH	On request
STANDARD WIDTH	25 - 30 - 36 - 40 - 50 - 60 mm
LIGHT WIDTH	30 mm
TENSION MEMBER	S and Z torsion high-performance zinked steel cords
FEATURES	Extreme traction and tensile strength for lifting systems

Flame retardant compound available on demand.



MEGADYNE RUBBER OPEN-ENDED	
SUPPLIED AS	Open-ended
LENGTH	On request
WIDTH	10 - 85 mm
PITCH	RPP5, RPP8, RPP14
TENSION MEMBER	Fiberglass, steel
FEATURES	High load capacity, reduced noise and vibration

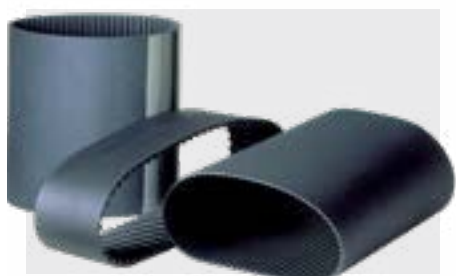

MEGADYNE MEGASYNC™ RUBBER ENDLESS TIMING BELTS	
SUPPLIED AS	Endless
LENGTH	248 - 4 956 mm
WIDTH	12 - 170 mm*
PITCH	SLV3 8M, SLV3 14M, GLD2 8M, GLD2 14M
TENSION MEMBER	Fiberglass
FEATURES	High-stability and resistance, antistatic

**Standard Width Range - Megadyne will cut to desired width upon request.*



MEGADYNE MEGASYNC™ TITANIUM

SUPPLIED AS	Endless
LENGTH	248 - 4 956 mm
WIDTH	12 - 170 mm*
PITCH	TTM8, TTM14
TENSION MEMBER	Dual spiral S & Z twist, 100% carbon cords
FEATURES	Superior power capacity with a more compact drive system

*Standard Width Range - Megadyne will cut to desired width upon request.



MEGADYNE POLYURETHANE TIMING BELTS

SUPPLIED AS	Open-ended, endless, joined, PPJ
LENGTH	MEGALINEAR on request MEGAFLEX 1,5 - 22,60 m
WIDTH	12 - 150 mm
PITCH	T10, AT5, AT10, AT20, RPP14, QST8, QST14, GW14, GW20
TENSION MEMBER	Steel, HP, HF, HPF, stainless-steel, Kevlar®
FEATURES	High resistance, customisable solutions



MEGADYNE V-BELTS

SUPPLIED AS	Endless, wrapped or raw-edge
LENGTH	410 - 16 992 mm
WIDTH	According to section
PITCH	Wrapped, narrow, raw-edge
TENSION MEMBER	Polyester
FEATURES	Long life and good performance



MEGADYNE PV RIBBED BELTS

SUPPLIED AS	Endless
LENGTH	350 - 16 764 mm
WIDTH	Consult Megadyne
PITCH	PH, PJ, PK, PL, PM
TENSION MEMBER	Polyester
FEATURES	Long life and good performance

METAL DRIVE COMPONENTS

Use an extensive range of pulleys and accessories like timing bars, flanges, clamping plates, couplings to design a complete drive transmission system.



ELEVATORS

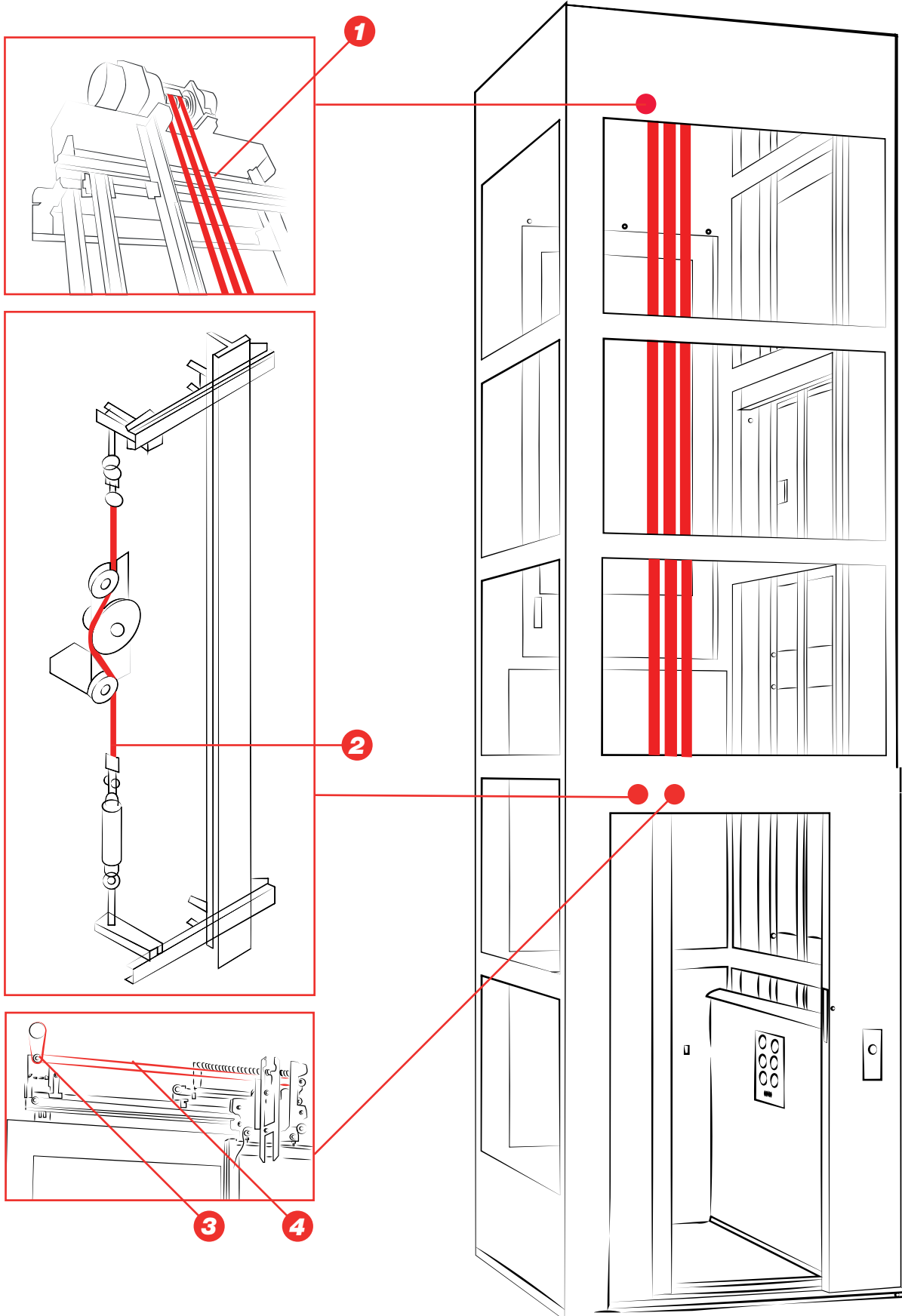



TRACTION BELTS MEGALINEAR P3.3

Thermoplastic flat PU belts, 92 ShA, supplied as open-length rolls and available in multiple versions: standard, light, and flame-retardant (on request).

- Operating in a wide variety of environments
- Space-saving
- Reduced elongation under load
- Fully sealed belt with high wear-resistance



MEGALINEAR

Thermoplastic PU 92 ShA belts with S & Z parallel cords (standard steel or high performance), supplied as open-length rolls or as endless jointed belts. (RPP14XHP, GW14, GW20, QST8, QST14).

- Constant dimension and length
- High wear-resistance

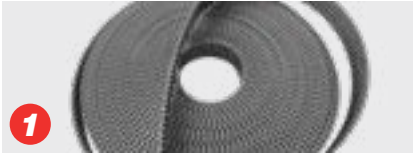

RUBBER OPEN-ENDED TIMING BELTS

Rubber base timing belts come from sleeves for spiral cut belts and from press for straight cut belts (RPP14 Steel).

- Very limited elongation
- Maximum traction load capacity



MEGALINEAR

Thermoplastic PU 92 ShA belts with S & Z parallel cords (standard steel or high performance), supplied as open-length rolls or as endless jointed belts.

- Constant dimension and length
- High wear-resistance

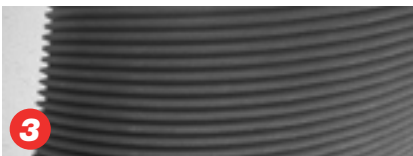

PV RUBBER RIBBED BELTS

Endless belts with longitudinal V-shaped grooves, which combine the benefits of flat belts and V-belts.

- Improved power performance by increasing the number of ribs
- Compact smooth-running drive system with low vibration



V-BELT

Wrapped V-belts, made of polybutadiene compound in a wide variety of sizes.

- Smooth-running operation.
- High transmission efficiency



MEGADYNE MEGASYNC™ RUBBER ENDLESS TIMING BELTS (RPP)

Rubber endless timing belts made of high-quality rubber compound and high performance tension members (RPP5, RPP8).

- High-power rating
- Reduced width and compact pulleys
- Low-noise



MEGALINEAR

Thermoplastic PU 92 ShA belts with S & Z parallel cords (standard steel or high performance), supplied as open length rolls or as endless jointed belts (RPP5, RPP8, STD5, STD8).

- Constant dimension and length
- High wear-resistance



RUBBER OPEN-ENDED TIMING BELTS

Rubber base timing belts come from sleeves for spiral cut belts and from press for straight cut belts (RPP5, RPP8).

- Very limited elongation
- Maximum traction load capacity

ESCALATORS

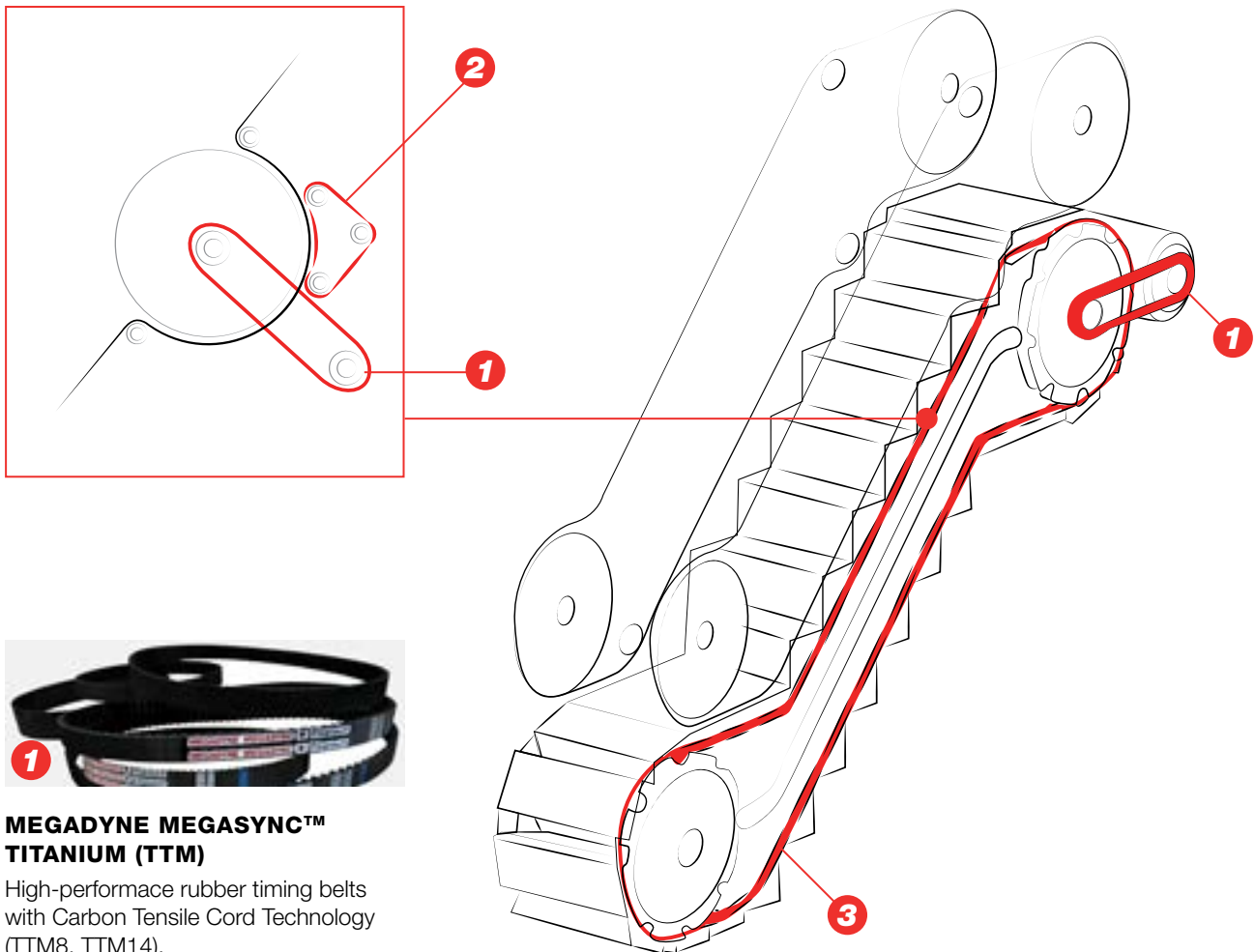

MEGADYNE MEGASYNC™ TITANIUM (TTM)

High-performance rubber timing belts with Carbon Tensile Cord Technology (TTM8, TTM14).

- Superior power capacity with a more compact drive system
- High-stability and resistance
- Long life cycles, cost-efficiency



MEGADYNE MEGASYNC™ GOLD2 (GLD2)

Rubber endless timing belts with spiral fiberglass cords and RPP profile (GLD2 8M, GLD2 14M).

- Low-friction coefficient
- High transmission efficiency
- Long-lasting
- Antistatic

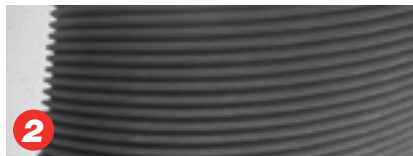

PV RUBBER RIBBED BELTS

Endless belts with longitudinal V-shaped grooves which combine the benefits of flat belts and V-belts.

- Improved power performance by increasing the number of ribs
- Compact smooth-running drive system with low vibration



MEGALINEAR

Thermoplastic PU 92 ShA belts with S & Z parallel cords (standard steel or high-performance), supplied as open length rolls or as endless jointed belts.

- Standard steel or high performance cords
- Constant dimension and length
- High wear-resistance

AUTOMATIC DOORS

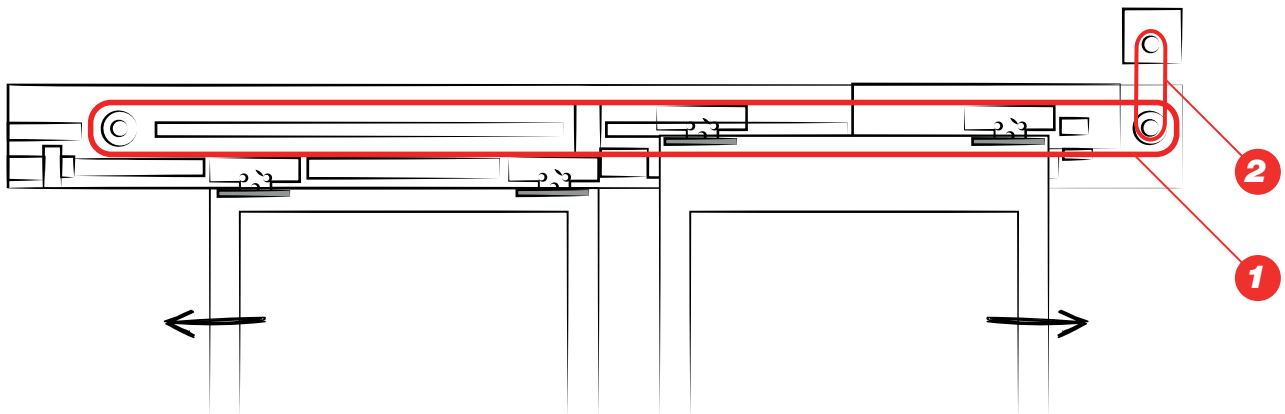

MEGALINEAR

Thermoplastic PU 92 ShA belts with S & Z parallel cords (standard steel or high-performance), supplied as open length rolls or as endless jointed belts.

- Constant dimension and length
- High wear-resistance

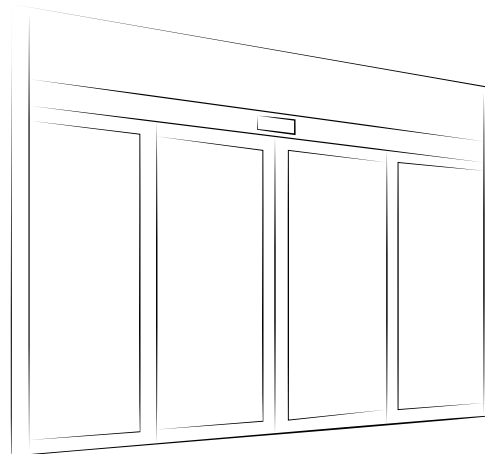

RUBBER OPEN-ENDED TIMING BELT

Rubber base timing belts come from sleeves for spiral cut belts and from press for straight cut belts (RPP5, RPP8).

- Very limited elongation
- Maximum traction load capacity



MEGADYNE MEGASYNC™ RUBBER ENDLESS TIMING BELTS (RPP)

Rubber endless timing belts made of high-quality rubber compound and high-performance tension members (RPP5, RPP8).

- High-power rating
- Reduced width and compact pulleys
- Low-noise



PV RUBBER RIBBED BELTS

Endless belts with longitudinal V-shaped grooves which combine the benefits of flat belts and V-belts.

- Improved power performance by increasing the number of ribs
- Compact smooth-running drive system with low vibration

GARAGE DOORS

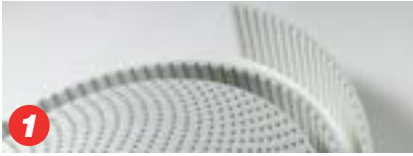

MEGALINEAR

Thermoplastic PU 92 ShA belts with S & Z parallel cords (standard steel or high-performance), supplied as open length rolls or as endless jointed belts.

- Standard steel or high-performance cords
- Constant dimension and length
- High wear-resistance

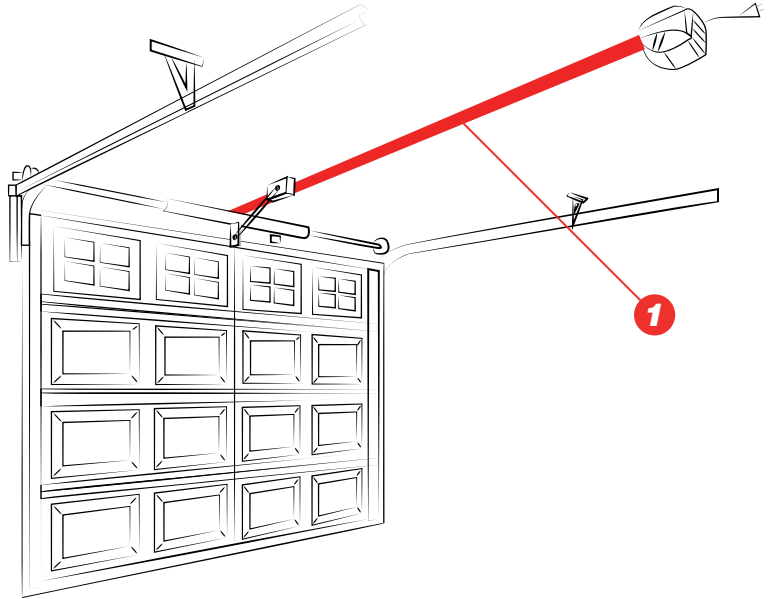

ROLL-UP DOORS



MEGADYNE MEGASYNC™ RUBBER ENDLESS TIMING BELTS (RPP)

Rubber endless timing belts made of high-quality rubber compound and high-performance tension members (RPP5, RPP8).

- High-power rating
- Reduced width and compact pulleys
- Low-noise

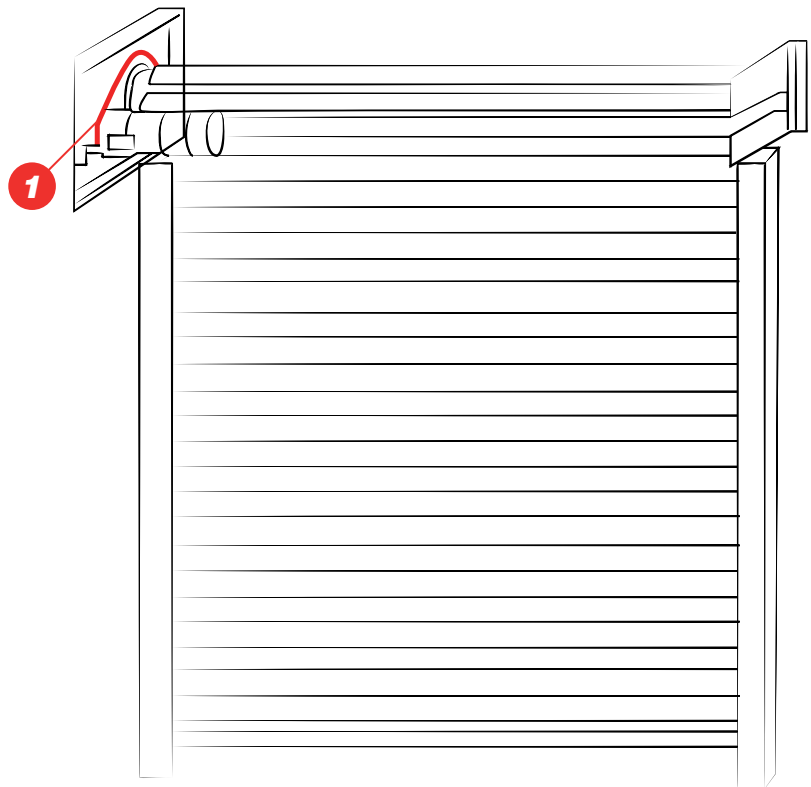

TURNSTILES

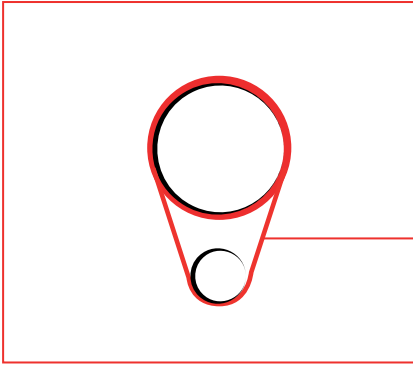

MEGADYNE MEGASYNC™ RUBBER ENDLESS TIMING BELTS (RPP)

Rubber endless timing belts made of high-quality rubber compound and high-performance tension members (RPP5, RPP8).

- High-power rating
- Reduced width and compact pulleys
- Low-noise

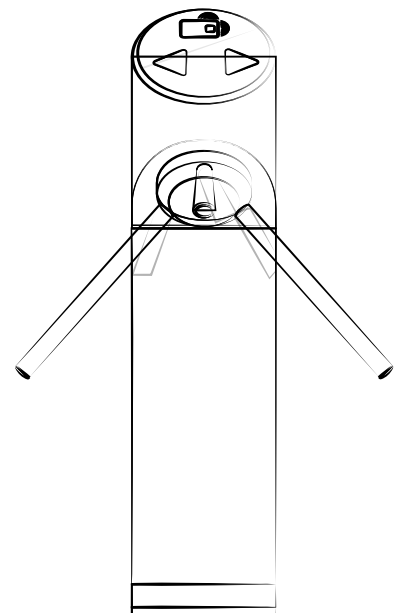
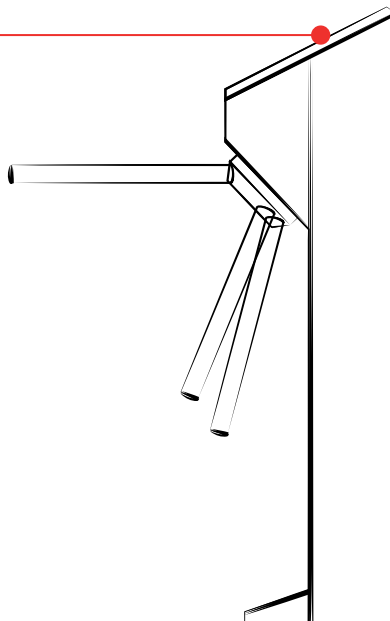
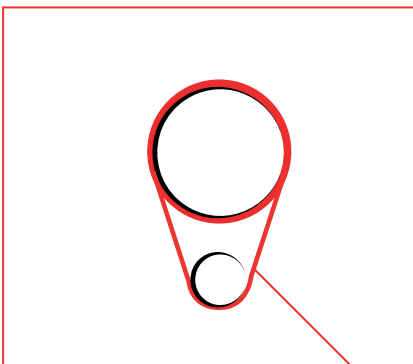
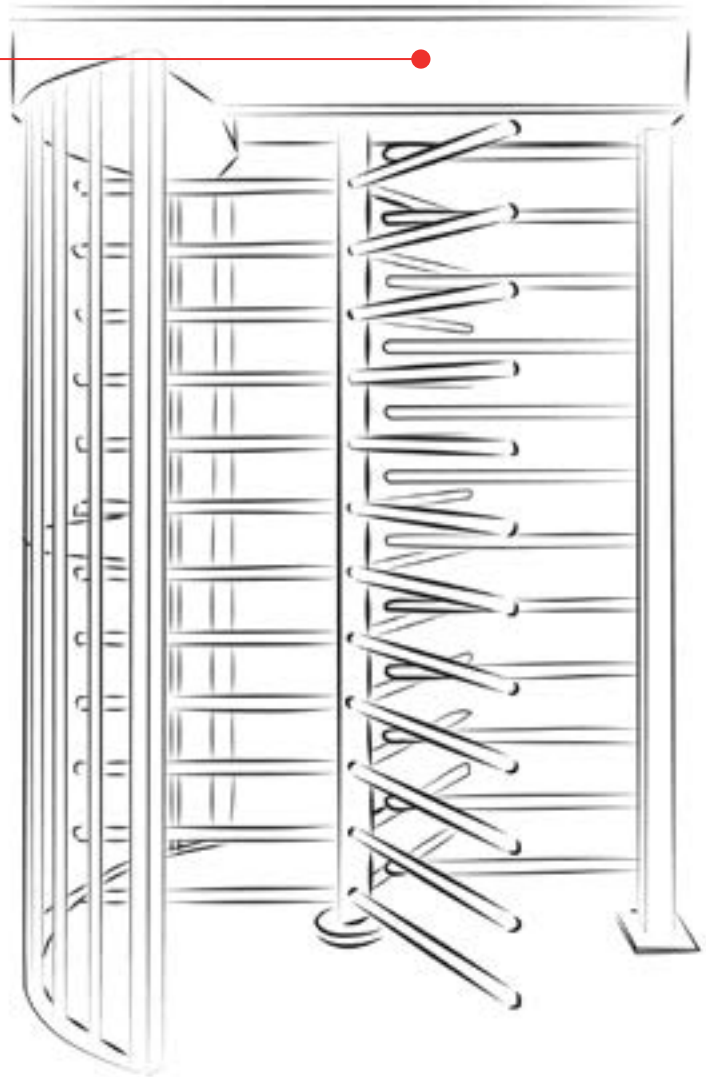



CASE STUDY

APPLICATION: Elevator traction system

PREVIOUS SOLUTION: Rope traction system

CHALLENGES OF THAT SYSTEM:

- Cabin vibration and oscillation
- Oxidation (rust) of exposed steel
- Higher energy consumption
- Greater wear on the traction sheave
- Larger traction sheaves require extra headroom (machine room)
- Large cabin rollers
- Short lifetime for the traction rope

MEGADYNE SOLUTION: MEGALINEAR P3.3

- No rust
- No vibration and less oscillation
- Reduced energy consumption
- Negligible traction sheave wear
- Smaller motor and sheave = Machine Room-Less
- Compact cabin peripherals
- Longer lifetime

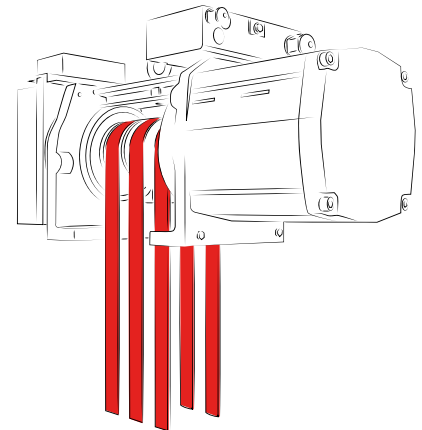

P3.3 CERTIFICATIONS



All P3.3 belts are compliant with EN 81-20 / EN 81-50 certifications. In addition, both standard and FR versions obtained ASME 17.1 certification for USA market and ASME 17.1 FT1 rating for whole FR range. Scan the QR Code to see the Liftinstituut Certificate.



ABOUT SUSTAINABILITY

Sustainability has always been a guiding principle for Ammega and all members of AMMEGA Group. We are proud to work with **EcoVadis** to monitor and evaluate our environmental, social and ethical performance.

At Megadyne, we are committed to becoming more and more responsible towards the world by reducing our impact on the planet. We work on new technological raw materials made by partners using the most ecological sustainable technologies. Our team has been working on the continuous improvement of products, services, and solutions for the benefit of society and the environment. Our vision is to be the local partner of choice for sustainable belting solutions around the globe.

Important sustainability achievements include improvements throughout the supply chain and in tracking our carbon footprint as well as the launch of new sustainable solutions for our clients. Major steps forward on sustainable investments are slowly bringing us closer to goals set in the Paris Agreement. We are on a journey towards a sustainable future, continually revising our plans and raising the level of our ambitions wherever possible. Our business performance and successes are key factors in defining our impact on the economic, social, and natural environment. We take the responsibility for this impact for all stakeholders and make every endeavour strengthen our roles as conscientious corporate citizens.

Megadyne, as a Member of AMMEGA Group, is embracing a more sustainable development approach and this has become our core long-term business strategy as demonstrated by the latest belting solutions designed for elevator segment:

MEGALINEAR P3.3 and MEGALINEAR QST.

Longer lifetime and high-resistance to wear result in cost-savings as while reduced motor size and pulley diameter lead to significantly reduced energy consumption.

OTHER CERTIFICATIONS



All Megadyne polyurethane power transmission belts comply with ISO 14001, ISO 9001 and European RoHS Directive. The belts are made with raw materials in compliance with REACH standards, meaning that all belts, pulleys, toothed bars, couplings blocking units and other items supplied by Megadyne do not contain one (or several) of the SVHC in Candidate List above a concentration of 0.1% w/w.

All Megadyne rubber power transmission belts are made in accordance with the Quality Management System Standard: ISO 9001 and ISO 14001. These certificates are valid for the following field of application: design, manufacture and sale of power transmission belts. Marketing of transmission and transport elements (pulleys, tensiometers).

Discover Your Local Contacts

The local partner of choice
for sustainable power transmission belting solutions
around the globe.



General contact information:

Megadyne
Via Trieste, 16
Via S. Lucia 114 - 10075 Mathi (Torino)
Italy



Scan the QR code
and find your local
contact

