

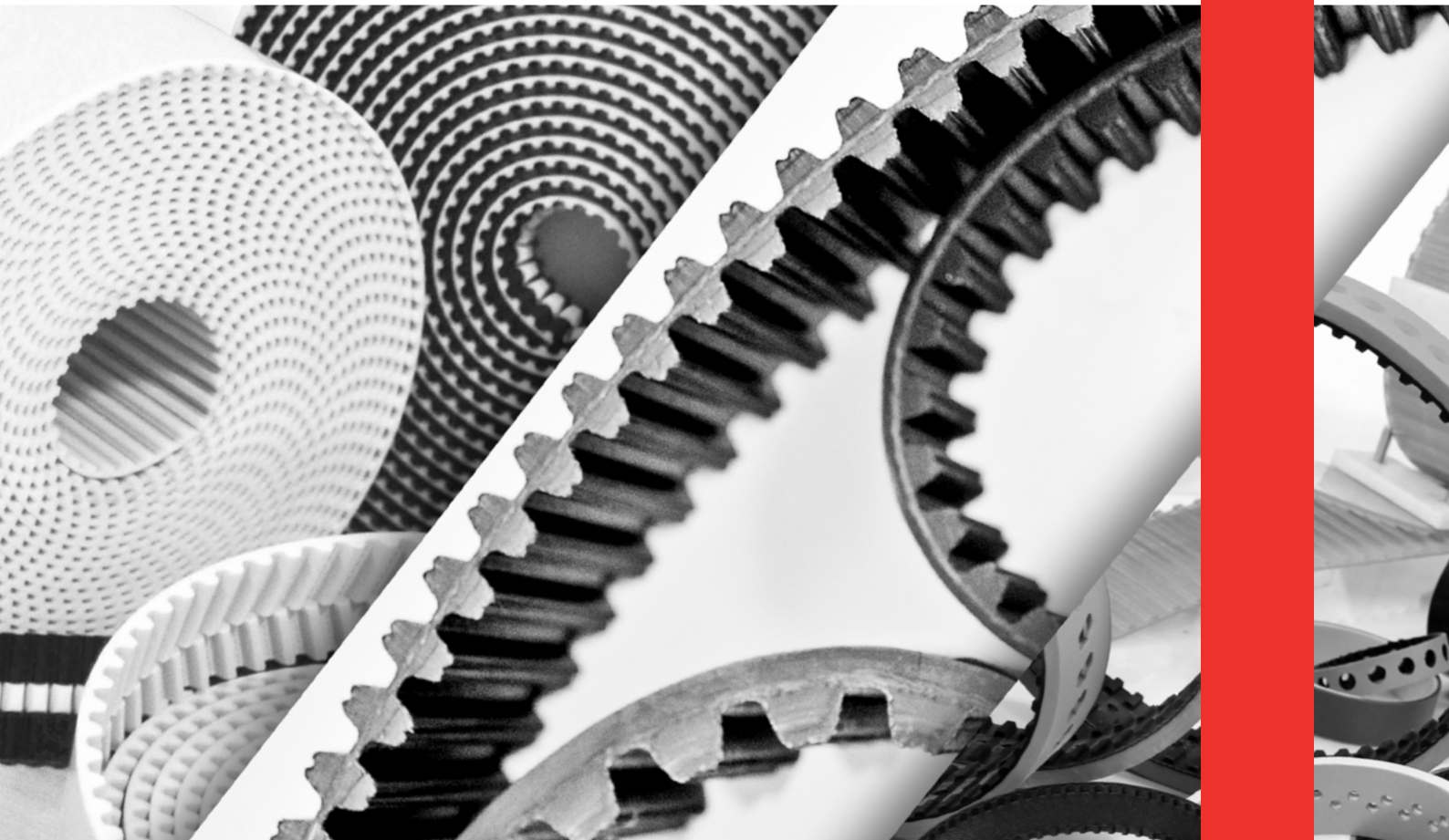

MEGADYNE



WELCOME TO MEGADYNE

PRODUCT
BROCHURE

EN

WELCOME TO **MEGADYNE**

Founded in 1957 and based in Mathi (Italy), Megadyne is a global product brand of rubber and urethane drive belts and associated components used in power transmission, product handling and linear positioning applications.

MATHI, ITALY



8



FACTORIES IN EUROPE, ASIA AND AMERICA

+170



COMMERCIAL LOCATIONS

Our extensive product portfolio is available globally in over 40 countries and 170 locations to support our OEM and SEM clients' businesses in their sustainability efforts.

After decades of growth, Megadyne continues to excel with a diverse portfolio of comprehensive power transmission and product handling solutions for all industry segments.

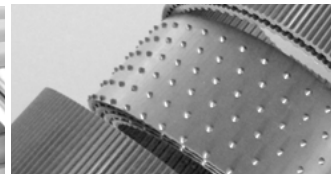
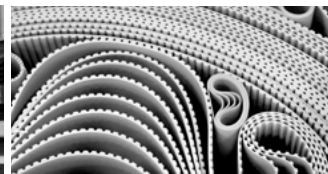
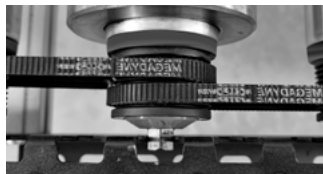
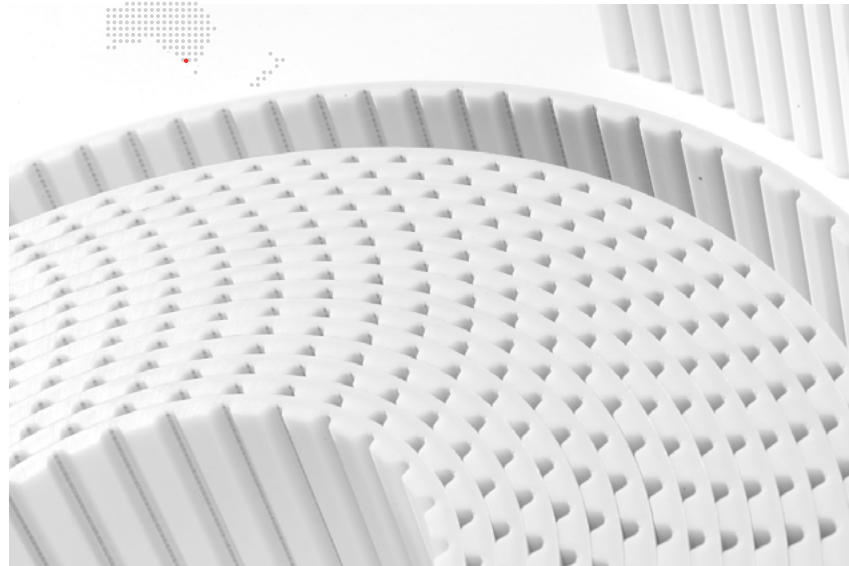

Inspire People

We care for our highly skilled employees, who cooperate in a diverse and inclusive environment as One AMMEGA Team. Our employees work collaboratively to foster productivity and continuous progress.

Customer Centricity

We are committed to the success of our customers, value their feedback, and craft solutions that fit their needs. Our goal is to build sustainable relationships.

Agility

The industry is driven by speed, our always-fast responsiveness and fast decision-making are a must in all our business areas.

Responsibility

We are part of a larger business community that we can help improve by working responsibly, by maintaining and increasing transparency, and by acting ethically and with integrity as good corporate citizens at all times.

Entrepreneurship

We empower our teams to think like entrepreneurs, making intelligent and informed decisions.

INDUSTRIES SERVED

Megadyne partners with Original Equipment Manufacturers and Distributors worldwide to engineer solutions for the most demanding applications in many industrial markets:



MEGAPORTAL

Discover our B2B platform area reserved for our customers.

MEGAPORTAL

1. Search for information and download technical manuals
2. Check product availability and price
3. Request a quote
4. Place your order
5. Track shipment
6. Review order details and history
7. Update account information



MAIN BENEFITS

 **Available 24/7**
Place your order or submit an enquiry anytime, anywhere, any device.

 **Real time data**
Access to current stock availability, pricing and delivery.

 **Easily track order status and history**
All order details are available at your fingertips - access current order details, order history and general account information.

 **Access relevant product information**
Discover new products, download product brochures and access additional product detail information.



MEGAPORTAL

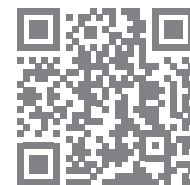

/Experience it yourself!

Scan the QR code

TIMING BELTS

MEGADYNE MEGASYNC™

Rubber endless timing belts available in single or double sided version, in classical pitches and RPP/PC profiles*. A large range of products available from stock.

**Please refer to the technical manual for detailed information*

SECTIONS:

MXL - XL - L - H - XH - XXH - XL DD - L DD - H DD
 STD 8M - HTB 3M - HTB 5M - HTB 8M - HTB 14M
 RPP3 - RPP5 - RPP8 - RPP14
 SLV3 5M - SLV3 8M - SLV3 14M - GLD2 5M** - GLD2 8M - GLD2
 14M TTM8 - TTM14
 RPP5 DD - RPP8 DD - RPP14 DD
 SLV3 8M DD - SLV3 14M DD** - GLD2 8M DD** - GLD2 14M DD**

***on demand*



RUBBER OPEN-ENDED

Open-ended belts especially suitable for linear drives, accurate positioning and bidimensional drives, where the rotation has to be translated into a linear position. Available in classical and RPP profiles.

SECTIONS:

MXL - XL - L - H - RPP3 - RPP5 - RPP8 - RPP 14
 SLV3 3M - SLV3 5M - SLV3 8M
 TTM 8M - TTM 14M
 (SLV3 14M - GLD2 5M - GLD2 14M)*

**on demand*



MEGAPOWER

Polyurethane endless timing belts manufactured using a unique thermoset moulding process.

SECTIONS:

MXL - XL - L* - H* - T2 - T2,5 - T2.5 DD
 T5* - T10* - T5 DD* - T10 DD*
 AT5 - AT10*

**available also with FC material*



MEGAFLEX

Polyurethane endless timing belts made of thermoplastic polyurethane, with a continuous spiral cord.

SECTIONS:

XL - L - H - XH - XL DD - L DD - H DD - XH DD
 T5 - T10 - T20 - T5 DD - T10 DD - T20 DD
 AT5 - AT10 - AT15 - AT20 - AT5 DD - AT10 DD
 - AT15 DD - AT20 DD
 MTD 8M - ATG10 K13
 RPP5 - RPP8 - RPP14 - RPP5 DD - RPP8 DD
 - RPP14 DD
 P2

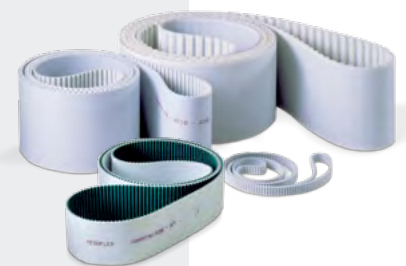

MEGALINEAR

Open-ended timing belts made in thermoplastic polyurethane, available in both open-ended or joined versions.

SECTIONS:

MXL - XL - L - H - XH - T2,5 - T5* - T10* - T20*
 AT3 - AT5* - AT10* - AT20*
 RPP5 - RPP8 - RPP14 - RPP14 XHP
 MTD3 - MTD5 - MTD8 - MTD14
 STD5 - STD8 - MEGAC4T™ AT10
 TG5 - TG10 K6 - TG10 K13 - TG20
 ATG5 - ATG10 K6 - ATG10 K13 - ATG20 - HG
 QST5 - QST8 - QST14
 GW14 - GW20 - P1 - P2 - P3 - P4

**Special compound and belt construction available for food contact applications (XMD, FC, FC-S). Please refer to the technical manual for detailed information.*

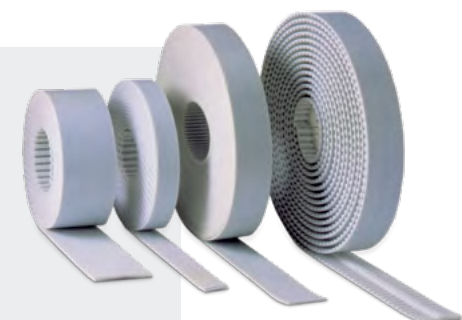

V-BELTS

OLEOSTATIC GOLD – OLEOSTATIC – EXTRA

OLEOSTATIC SECTIONS:

20 - 25 - 45 - 50 - 3V - 5V - 8V

OLEOSTATIC GOLD SECTIONS:

Z - A - B - C - D - E - SPZ - SPA - SPB - SPC

EXTRA SECTIONS:

Z - A - B - C - SPZ - SPA - SPB - SPC



ESAFLEX

SECTIONS:

AA - BB - CC



XDV2

SECTIONS:

XDV38 - XDV48 - XDV58



LINEA GOLD

SECTIONS:

AX - BX - CX - XPZ - XPA - XPB - XPC



LINEA X

SECTIONS:

XPZ - XPA - XPB - XPC



VARISECT

SECTIONS:

13X6 - 17X6 - 21X7 - 22X8 - 26X8 - 28X8
- 30X10 - 32X10 - 36X12 - 37X10 - 42X13 -
47X13 - 52X16 - 55X16 - 65X20 - 70X20



PLURIBAND

SECTIONS:

RA - RB - RC - RSPZ - RSPA - RSPB - RSPC
R3V - R5V - R8V - R3VX - R5VX



MEGAWELD

A wide selection of trapezoidal and round weldable belts made in thermoplastic polyurethane by a unique extrusion process and suitable for numerous applications.

ACCU-LINK®

Accu-link® may be used as an emergency belt in place of V-belts in case of unexpected failure, but is also originally installed in many industrial sectors.



FLAT BELTS

MEGAFLAT PU

Flat belts truly endless mandrel moulded, available with polyester, aramid or cotton reinforcements.

SECTIONS:

P0 - P102 - P108 - P110 - P120 - P155
S108 - S110 - S120 - S155

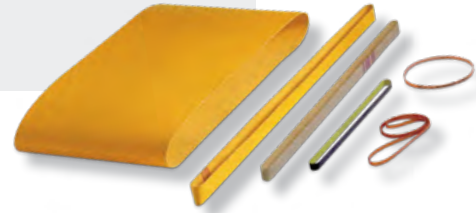

MULTI-RIB BELTS

PV BELTS

Endless rubber belts with longitudinal V-shaped grooves providing high flexibility and great power performance.

SECTIONS:

PH - PJ - PK - PL - PM

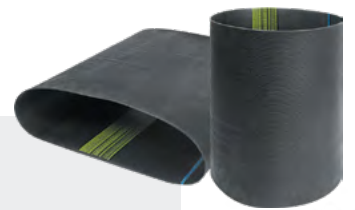

ROLLPOWER™

The new elastic rubber ribbed belt designed to outperform in roller conveyor applications.

SECTIONS:

PJ



MEGARIB

Ribbed belts manufactured using a thermoset compound with polyester or polyamide high tension cord.

SECTIONS:

PJ - PH - PTB2

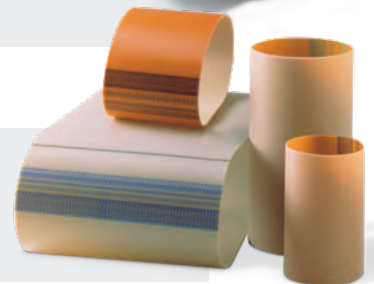

METAL DRIVE COMPONENTS

Megadyne stocks and supplies an extensive range of pulleys and accessories like timing bars, taper bushes, flanges, clamping plates... to offer a complete drive transmission system.

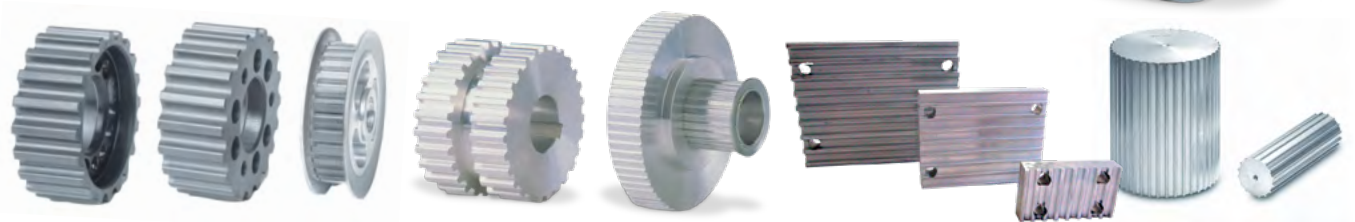

SPECIAL & FABRICATED BELTS

COVERS AND MODIFICATIONS

Megadyne can fully customise its belts with a variety of covers - in polyurethane, rubber elastomer, foam, PVC - and the following special modifications:

- CLEATS
- FALSE TEETH
- CUSTOM SHAPES
- GRINDING
- NOTCHING/KNIFE CUT
- FABRIC ADDED TO THE TOOTH SIDE OF BELT
- HOLES/PERFORATIONS/GROOVES /VACUUM COUNTERSINKS
- POCKETS
- SLOTS
- SAW TOOTH

Some engineered belts are now available in stock for quick delivery: ask for more information!



PPJ SYSTEM

Very fast belt replacement system to join belts directly on the machine.

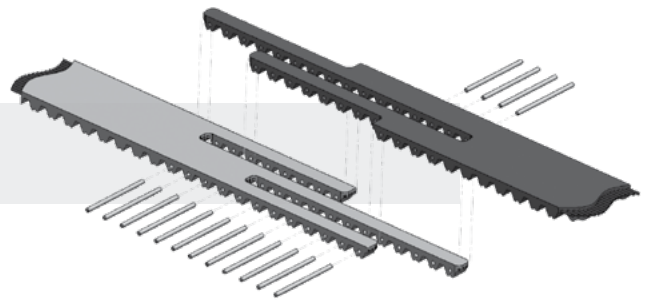

CERTIFICATIONS



All Megadyne polyurethane power transmission belts comply with ISO 14001, ISO 9001 and European RoHS Directive. The belts are made with raw materials in compliance with REACH standards, meaning that all belts, pulleys, toothed bars, couplings blocking units and other items supplied by Megadyne do not contain one (or several) of the SVHC in Candidate List above a concentration of 0.1% w/w.

All Megadyne rubber power transmission belts are made in accordance with the Quality Management System Standard: ISO 9001 and ISO 14001. These certificates are valid for the following field of application: design, manufacture and sale of power transmission belts. Marketing of transmission and transport elements (pulleys, tensiometers).

MEMBERSHIPS



Discover Your Local Contacts

The local partner of choice
for sustainable power transmission belting solutions
around the globe.



General contact information:

Megadyne

Via Trieste, 16

Via S. Lucia 114 - 10075 Mathi (Torino)

Italy

www.megadynegroup.com



Scan the QR code
and find your local
contact

